

Your Global Automation Partner

# TURCK

## IO-Link All-in-One Solutions Enabler for Industry 4.0

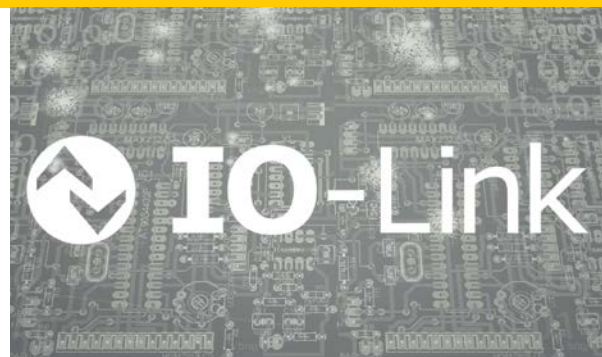

# IO-Link – Enabler for Cost-efficient Digitization

The planning and building of machines is usually a costly matter. Standardized interfaces and products help customers to save costs in terms of storage of different devices or the commissioning of all machines. IO-Link is the innovative standard applied on the lowest field level to relieve electrical planning, maintenance and purchasing in the daily process. On the way to the digital factory, the user benefits from more efficient production processes in smallest quantities, but also quality assurance and sustainable availability of the entire system.

## Consistent IO-Link Portfolio

A major prerequisite for this is the availability of all relevant data at any time in any required place. Turck provides powerful solutions that capture, prepare and transmit relevant production data and support the key technologies such as RFID, Ethernet, OPC-UA and IO-Link.

The necessary software components for integrating IO-Link devices are a part of the broad portfolio of course.

# Table of Contents

<b>IO-Link - Simple, Consistent, Efficient</b>	
What is IO-Link?   Standard cabling   Your benefits   IO-Link system expertise	4
Plug & Play device integration	4
<b>Customer Benefits</b>	
Reduced machine costs	5
More efficient production processes	5
Increased availability of machines and plants	5
<b>IO-Link Overview</b>	
Engineering tool integration	6
Device identification	6
Cabling	6
Ethernet/Fieldbus connection	7
Sensor mounting	7
I/O hubs	7
<b>IO-Link Applications</b>	
Signal transmission in gearbox production	8
Position detection in fairground rides	9
Recording the swing movement of a core shooter	10
Data communication in silencer production	11
Contactless data and energy transmission	12
Preventive maintenance on conveyor belts	13
<b>IO-Link Devices</b>	
Inductive sensors	14
Capacitive sensors	16
Ultrasonic sensors	18
Measuring light screens	20
Linear position sensors	22
Encoders and inclinometers	24
Pressure sensors	26
Temperature sensors	30
Flow sensors	34
Laser sensors	38
Clear object sensors	40
Optical sensors	42
LED tower lights TL50	44
Control cabinets	46
I/O hubs	48
<b>IO-Link Connectivity</b>	
NIC coupler system	50
Ethernet cables	52
Connecting cables M12 × 1	54
<b>IO-Link Master</b>	
IO-Link Master	56

# IO-Link - Simple, Consistent, Efficient

## What is IO-Link?

IO-Link builds on a point to point connection between a sensor/actuator and an interface module. Up to now, the binary connection was only designed to transmit pure switching information, but IO-Link typically enables two bytes to be transmitted via a combined switching state and data channel at intervals of 2 ms. In addition to these process values, other information such as parameters or diagnostic messages can be exchanged. This way, the entire process down to the sensors is covered to enable integrated communication.

## Standard cabling

IO-Link requires no special cabling. The well-established, reasonably priced and unshielded three-wire industrial cables can still be used to connect sensors and actuators. It is possible to choose between the standard switching and communication operating modes.

## Your benefits

As an IO-Link user, you benefit from a multitude of advantages, in particular reduced machine costs, more efficient production processes and the improved availability of your machines and plants.

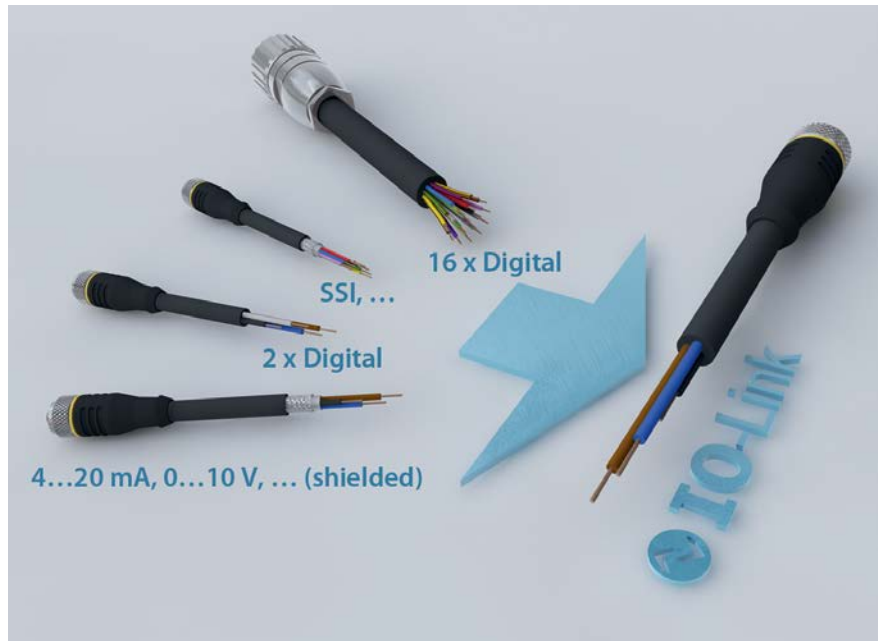

## IO-Link system expertise

Turck not only offers you one of the most extensive portfolios of IO-Link solutions – from a multitude of sensors to cables and I/O hubs right up to programmable fieldbus and Ethernet solutions – but also outstanding system expertise. Take advantage of the many years of experience that Turck has in this technology, the resulting product portfolio and user-friendly software support.

## Plug & Play device integration

The setting options of all our in-house IO-Link devices are integrated in the station GSDML files of the IO-Link master of the TBEN family. This greatly simplifies the configuration. When reading the GSDML file into a project planning software, such as TIA Portal or others, all Turck devices can be selected as a specific port configuration. Additional parametrization or programming is no longer required.

# Customer Benefits



**Reduced machine costs**

- Reduced stockpiling due to parametrizable multi-function devices
- Only one I/O module and cost-efficient standard cable
- Low number of I/Os possible
- Devices with display and buttons no longer required
- Reduced engineering and installation costs and automatic documentation of device parameters during engineering work

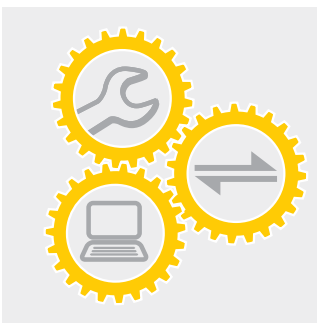

**More efficient production processes**

- Simple parameter changes when replacing devices
- Quicker changes to parameter sets for switching thresholds, amplification, sensitivity, etc. for different production conditions
- Quicker and more reliable tool changes

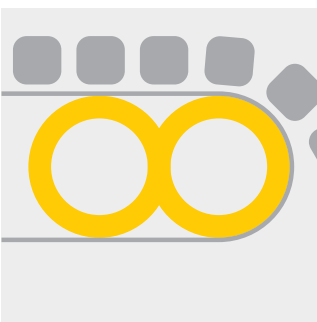

**Increased availability of machines and plants**

- Extensive status information and diagnostic options in the plant lead to drastically reduced machine downtimes
- Expanded information enables cost-cutting measures such as predictive maintenance and asset management
- Automatic acceptance of parametrization enables devices to be replaced with fewer qualified personnel

# IO-Link Overview

## Engineering tool integration

Standardized interfaces such as DTM and IODD enable complete, seamless integration in engineering tools, as well as in stand-alone tools such as asset management or configuration tools. Software solutions can also be incorporated at the company level via standard Ethernet.

## Device identification

The integrated device identification ensures that the right device is installed if a component is replaced. Because each device contains detailed information about the manufacturer, type, etc., IO-Link enables a quick replacement with a high level of reliability.

## Cabling

With IO-Link, the same unshielded, three-wire standard cable with an identical pin assignment can be used as with conventional I/Os. This eliminates problems with complex devices that do not have pin assignment standards and often have multi-pole connectors.

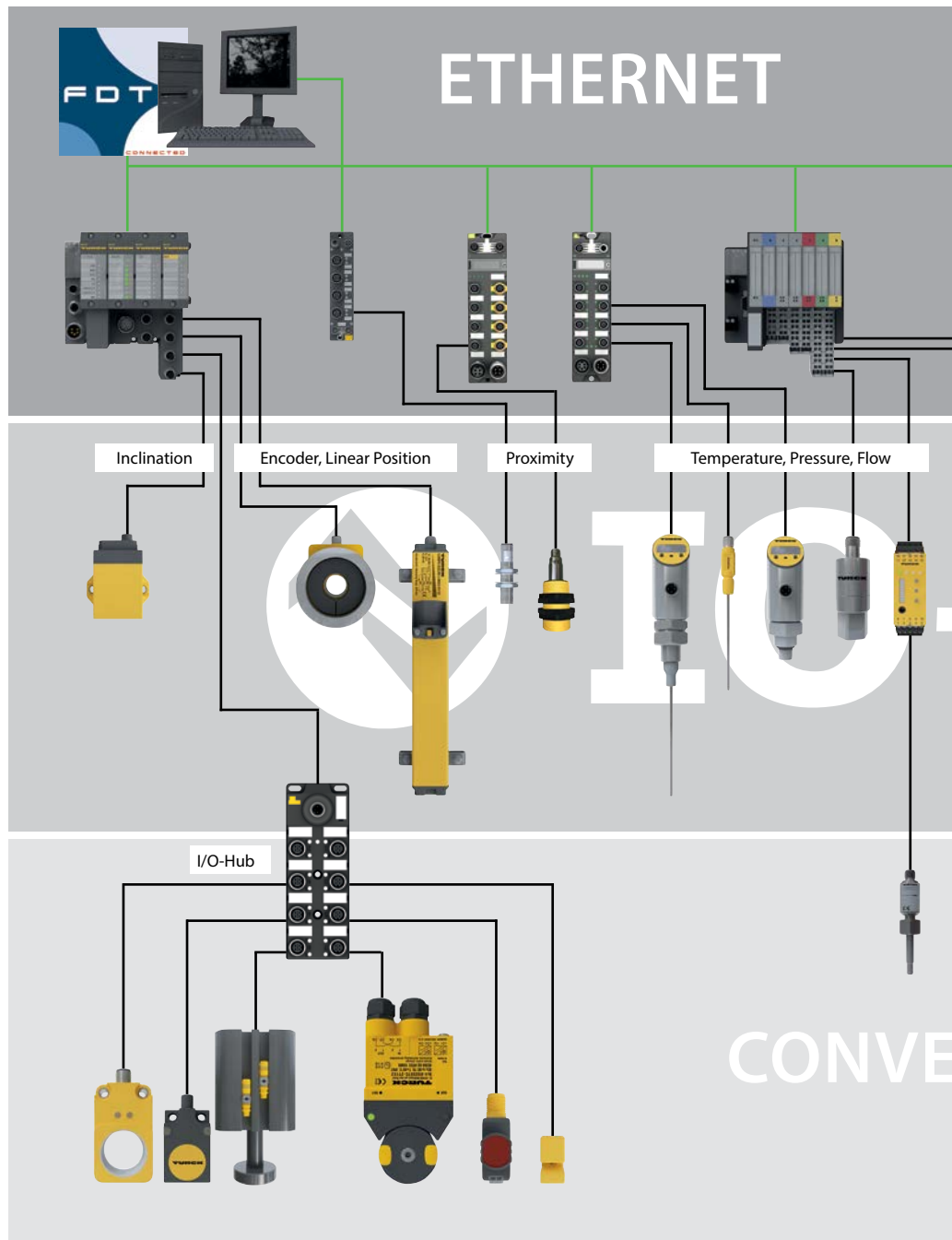



# FIELD BUS

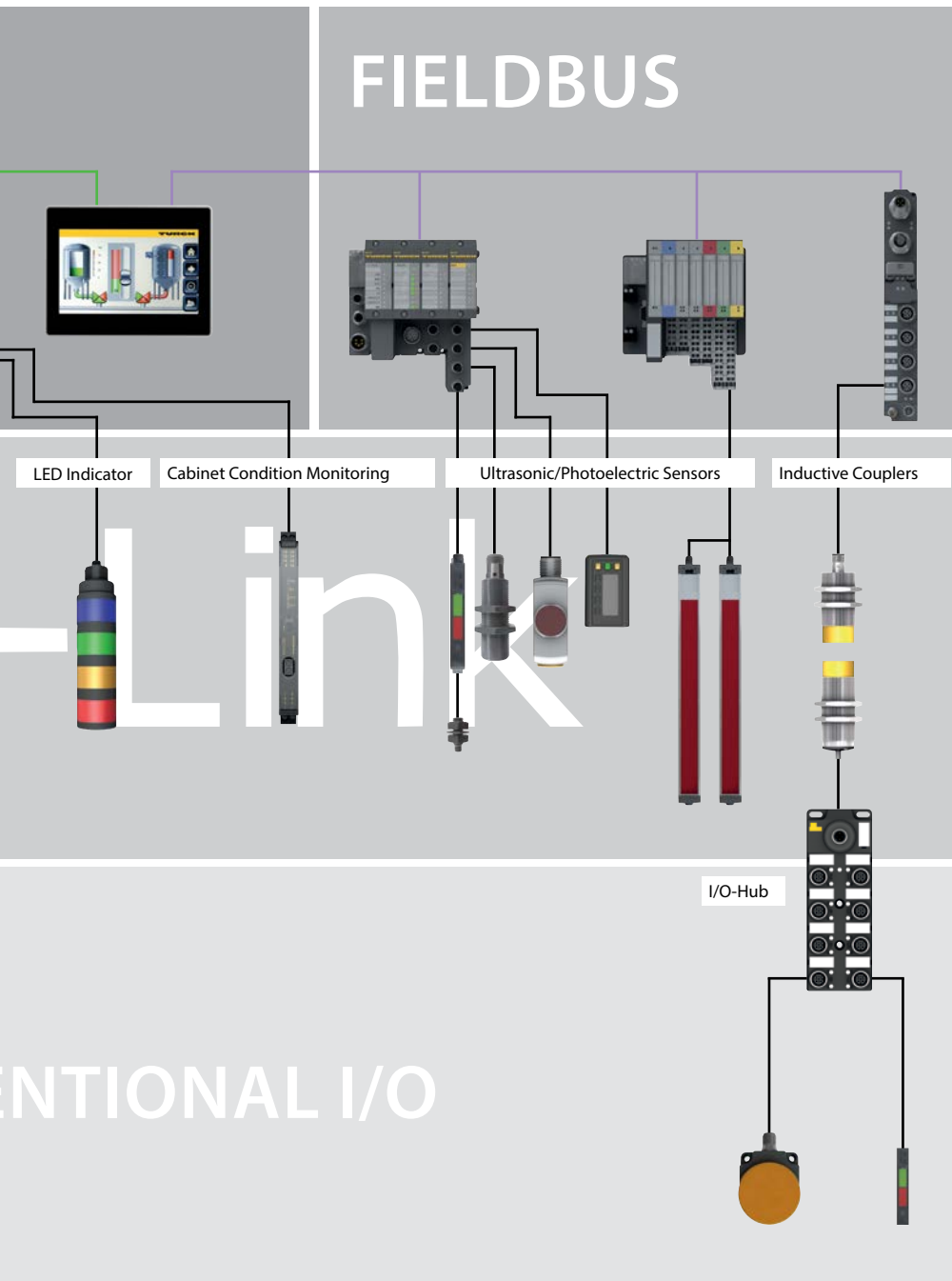

## Ethernet/Fieldbus connection

IO-Link enables a connection to all major fieldbus types as well as Ethernet. Turck offers solutions for the entire spectrum, from master modules for its modular I/O systems BL20 and BL67 to multiprotocol Ethernet gateways that can be used in PROFINET, EtherNet/IP and Modbus TCP networks thanks to their automatic protocol detection.

## Sensor mounting

All IO-Link devices enable parameter changes and diagnostics via engineering systems or separate tools. Because the user does not need to access the display or switches, the devices can be installed in the machine in the exact location that makes sense for the application.

## I/O hubs

All standard 24-VDC devices can be incorporated into automation systems via IO-Link using the I/O hubs from Turck. The hubs are available with inputs and outputs as well as combined variants with universal digital I/Os.

# IO-Link Applications

Turck has already implemented IO-Link solutions in numerous applications for its customers in a wide range of industries. We will give you a few case studies here.

## Signal transmission in gearbox production

On the production line for differential gears of an automotive supplier, numerous magnetic field sensors detect the positions of pneumatic cylinders and grippers, while proximity switches detect components of the differentials themselves. In addition, there are also a large number of actuators such as pressure relief valves, solenoid valves and other devices that carry out the commands delivered by the controller.

The original plan to connect the numerous signals with passive junction boxes and multi-core cables to fieldbus gate-

ways in the control cabinet was quickly discarded. The costs of cables and the wiring effort were too high.

With its IO-Link-capable I/O hubs, Turck was able to offer a space-saving solution that considerably simplified the wiring and was still cost-efficient. Furthermore, the system enables a diagnosis down to the sensor level. A PROFIBUS BL20 gateway with IO-Link master modules ensures a connection to the controller. TBIL junction boxes from Turck are ideal for connecting the sensors and actuators in the field. These I/O hubs use IO-Link

to send up to 16 binary signals to the IO-Link-Master via a standard sensor cable. In this case, the 16-bit process signal of the IO-Link protocol is therefore not used for an analog process value, rather for the transmission of 16 individual switching signals – whether digital input or output signals. Because the I/O hubs fulfill the requirements of protection class IP67, they can be mounted directly in the field.

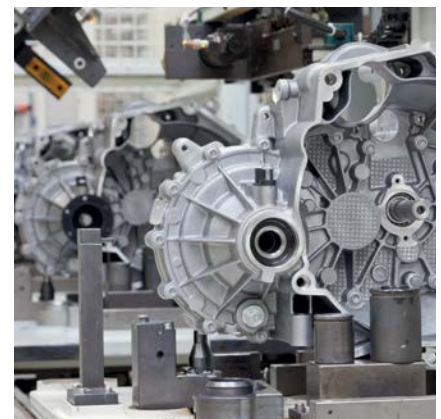



## Position detection in fairground rides

In the past, to determine the horizontal position of the arms of a fairground ride, the manufacturer has installed five sensors on each hydraulic lifting cylinder. Although this ensured safe operation, a great deal of effort was required to install and configure the sensors and it was not possible to detect the exact position of the car at all times.

Now, Turck Li-linear position sensors detect the lift of hydraulic cylinder over its entire length of 1,000 millimeters. Even during rapid rides and with the centrifugal forces that occur, the sensor delivers

the exact position of the positioning element by means of the analog 4 to 20 mA signal. On the control side, the exact position of the arm can thus be determined easily at all times.

For safety reasons, a possible failure of the positioning element must be reliably detected and reported to the controller. The Li sensor is also ideal for this due to the fact that it can be parametrized using IO-Link. Via the IO-Link interface, the user can also define measuring ranges, invert the output signal or have special signals emitted, such as the failure signal, from

the controller. The controller recognizes this special case and shuts down the system by means of a defined safety routine.



# IO-Link Applications

## Recording the swing movement of a core shooter

Core shooters produce sand cores for metal casting. In the process, a key objective of the manufacturer is to achieve short cycle times. With his new generation of machines, the manufacturer consistently automates using IO-Link. This offers many advantages: The manufacturer not only saves money but also time during the configuration, wiring and electrical planning, and customers benefit from a more dynamic machine. Errors occur less frequently and can be diagnosed more easily. The swing movement of the core carrier, which is recorded by the contactless IO-Link encoder QR24-IOL from Turck, is a major influence on the clock rate of the machine.

The numerous intelligent components that had previously been used usually had one bus connection. Consequent-

ly, the operating voltage and two bus cables had to be connected separately. All three cables were laid on drag chains and, consequently, were highly stressed. To detect faults such as a cable break, the technicians had to use complex diagnostic systems or search for a very long time.

IO-Link eliminates many of these disadvantages: The two bus cables and the voltage supply have been replaced with a standard three-wire cable, which is guided in the drag chains. All intelligent, analog sensors and devices now have an IO-Link interface and are connected to the controller via IO-Link masters, simple proximity switches and digital actuators via IO-Link-capable junction boxes. In this way, 16 switching signals can be connected via a standard three-wire cable, which significantly reduces the wiring effort.

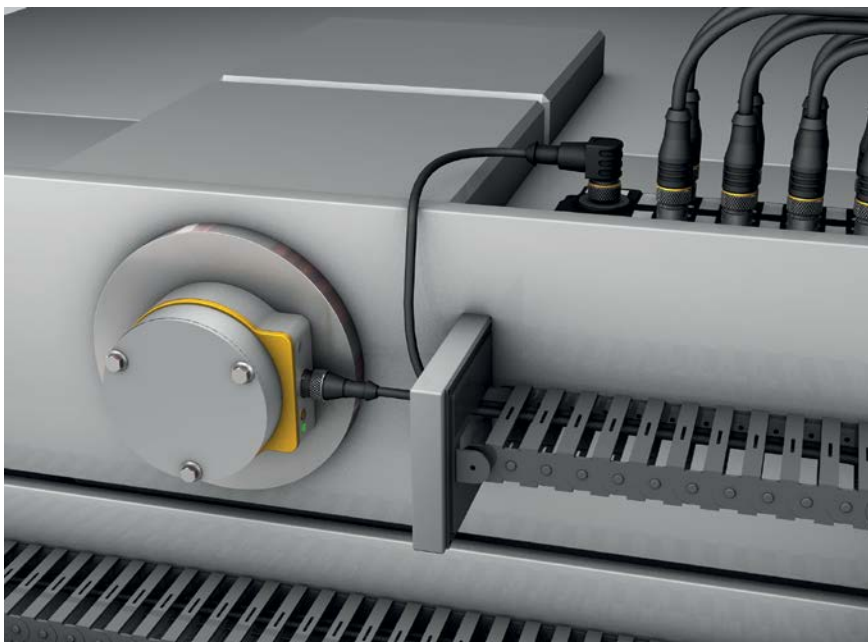

## Data communication in silencer production

In a new silencer production line, a manufacturer of exhaust systems relies on the Turck fieldbus system BL20 and the IO-Link-capable TBIL passive junction box. A unique feature of the new production line is that fieldbus systems must communicate with various controllers – an ideal field of application for the modular IP20 I/O system BL20. The multiprotocol gateways, which support PROFINET, EtherNet/IP and Modbus TCP, send the various signals to the controller and also connect various valve clusters of the production line.

BL20-4IOL gateways with IO-Link master modules and the IO-Link capable IP67 I/O hubs TBIL send up to 16 switching signals from the field to the control cabinet via a simple 4-wire cable. In addition to the input signals, the actuator signals are

transmitted to the valve clusters so that a single interface can take over all data communication on site.

In light of the fact that errors in the connection technology can most effectively be avoided by reducing the number of connection cables, a smart IO-Link solution, such as in this example, is not only significantly simpler, quicker and more economical to implement than multipole cable-systems, they also contribute a great deal towards quality assurance. Furthermore, digital IO-Link signal transmission is insensitive to electro-magnetic interference such as in production line for MIG welding (metal inert gas welding). In this way, the user saves on expensive shielded cables and other EMC protective measures.

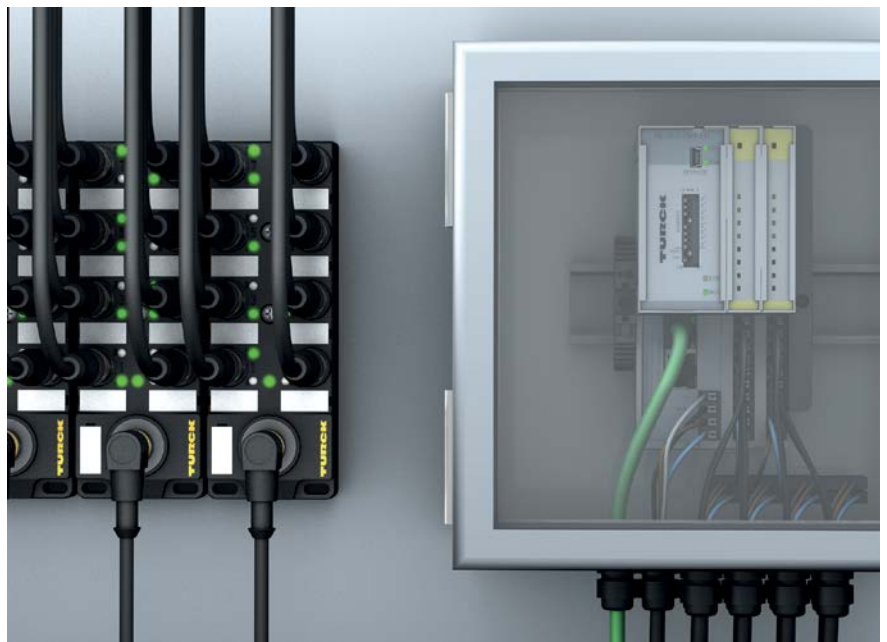

# IO-Link Applications

## Contactless data and energy transmission

In numerous applications, such as tool changes by robots, on workpiece carriers or in the identification of press tools, the fixed machine part and the tool previously had to be both mechanically and electrically connected for the transmission of energy and I/O data.

For this reason, the electrical connections require multi-pin connectors and multi-wire cables. Due to the frequent plug cycles, these connections are highly stressed and must ensure a high level of contact reliability. This results in high investment costs and more frequent production downtime due to wear and tear.

Turck contactless inductive NIC couples represent an alternative solution for the contactless transmission of data and energy. The couplers transfer a power of up to

12 Watts and can be operated with an IO-Link device. This can either be an IO-Link sensor or a Turck I/O hub, via which up to 16 switching signals can be transmitted using IO-Link.

The I/O hub also enables tools or workpiece carriers to be identified by means of the application-specific tag of the IO-Link protocol.

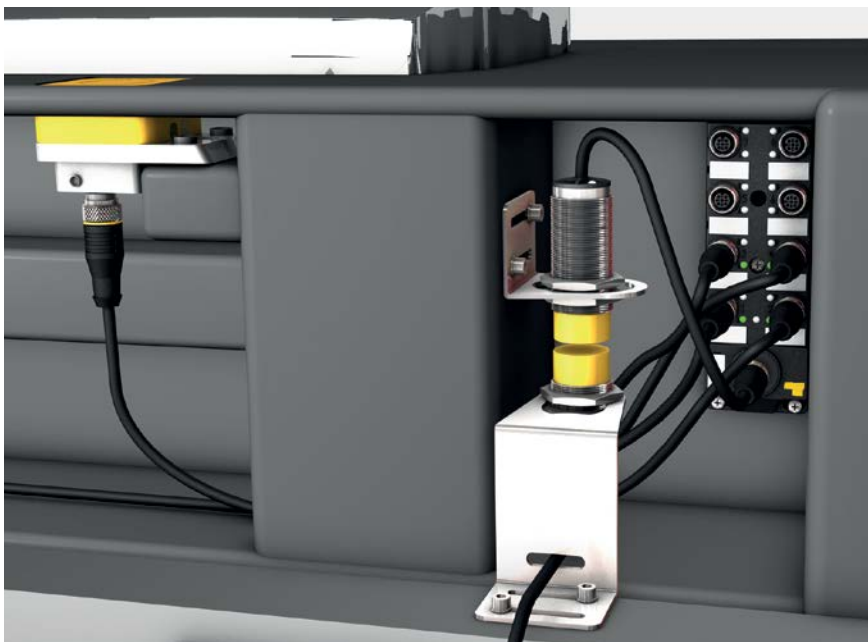

## Preventive maintenance on conveyor belts

There are various options for detecting the presence of objects on conveyor systems. Besides sensor systems, ultrasonic reflection measurements offer an error-free and efficient alternative.

The RU ultrasonic sensor series from Turck detects objects with high precision. These sensors can be used as reflective barriers, among other things.

The RU sensors have switching and analog outputs as well as an IO-Link interface. Using IO-Link or teach buttons, the user can choose between the diffuse or retroreflective modes and the NC or NO switching output. The flexibly adjustable operating modes and the short blind zones with large detection ranges effectively reduce the range of variations that are stockpiled.

Because, in addition to the wanted signal, the sensors also detect the signal quality, they are ideal for preventive maintenance. Using the signal quality, the user can determine whether an acute fault has occurred, such as a reflector being torn off, or if the system can be repaired during scheduled downtime.

Because the devices can also display and compensate the internal temperature and external temperature fluctuations, they are always ready to use, irrespective of the ambient conditions.



# Inductive Sensors



With uprox<sup>®</sup>3 IO-Link Turck offers the factor 1 sensors now also with IO-Link interface. The flexibility thus obtained makes the uprox<sup>®</sup>3 IO-Link sensor the "Swiss army knife" of factor 1 sensors. The range of functions include adjustable switching outputs, different output functions (PNP/NPN, NO/NC), various speed monitoring functions and advanced sensor data such as the internal sensor temperature or sensor ID data.

## Features

- Safe investment through IO-Link 1.1
- Improved availability through diagnostics
- Highest switching distances and factor 1
- Increased flexibility in the application

## Type Code

**B i 10 U - M18 - IOL 6 X2 - H1 1 4 1**

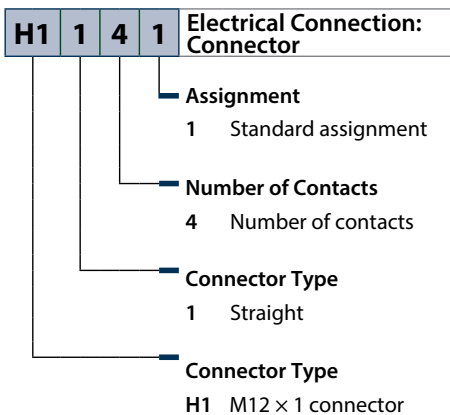
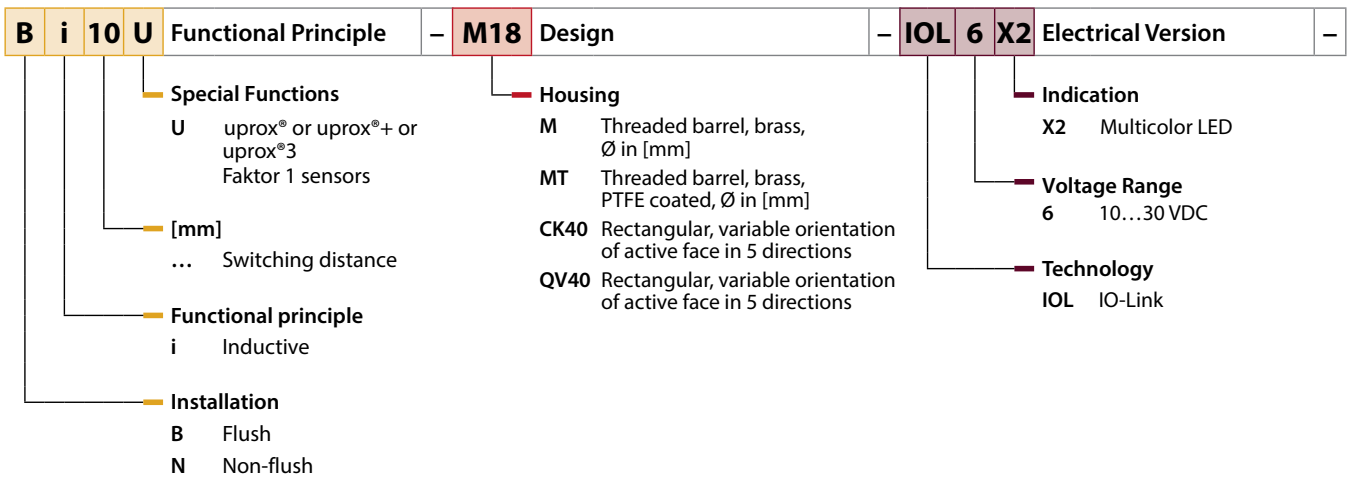

## Inductive Sensors



### General data

Communication Mode	COM 2 (38.4 kBaud)	IO-Link Specification	V 1.1
IO-Link port type	Class A		

### Types and Data – Selection table

Type	ID number	Switching distance [mm]	Mounting conditions	Designation	Dimensions [mm]	Housing material
BI6U-M12-IOL6X2-H1141	1644873	6		M12 x 1	12 x 52	Metal
BI6U-MT12-IOL6X2-H1141	1644874	6		M12 x 1	12 x 52	Metal
BI10U-M18-IOL6X2-H1141	1644875	10		M18 x 1	18 x 52	Metal
BI10U-MT18-IOL6X2-H1141	1644876	10		M18 x 1	18 x 52	Metal
BI20U-M30-IOL6X2-H1141	1644882	20		M30 x 1.5	30 x 62	Metal
BI20U-MT30-IOL6X2-H1141	1644883	20		M30 x 1.5	30 x 62	Metal
NI50U-CK40-IOL6X2-H1141	1625871	50		CK40	65 x 40 x 40	Plastic
NI50U-QV40-IOL6X2-H1141	1625872	50		QV40	65 x 40 x 40	Plastic

# Capacitive Sensors BCT



The capacitive sensors of the new BCT series with IO-Link reduce the effort for adjusting switch point and extend the usefulness of the measuring signals through a digitized 12-bit process value. Thanks to the optimized compensation of wetting on the sensor surface, deposits can be faded out and a drift of the switchpoint prevented.

## Features

- More efficient commissioning through IO-Link
- Increased system availability with internal temperature monitoring
- Reliable measurement results through optimal wetting compensation

## Type Code

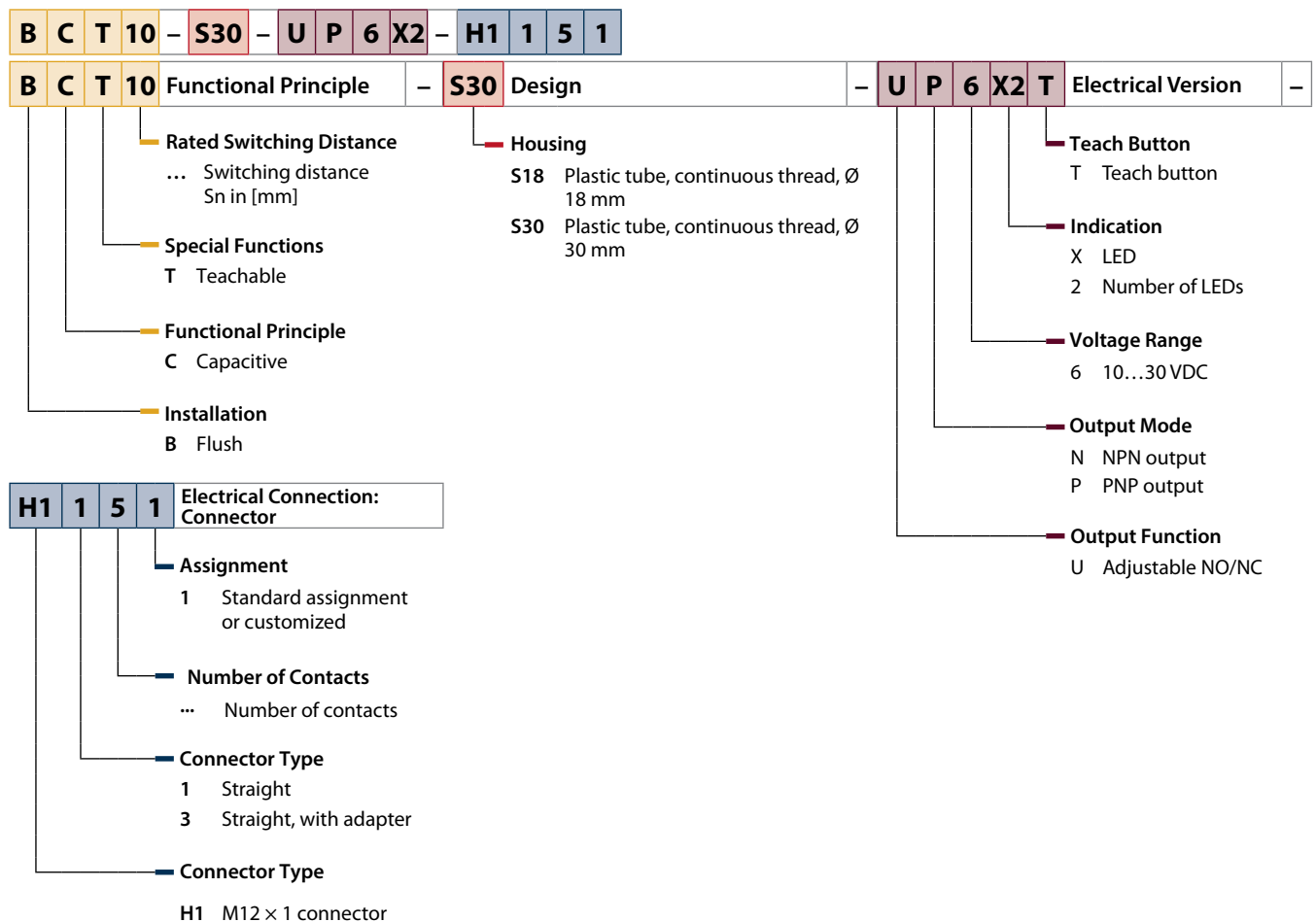



## Capacitive Sensors BCT



General data			
<b>Mounting conditions</b>	Flush	<b>Operating current</b>	200 DC
<b>Electrical connection</b>	Connector, M12 × 1	<b>Housing material</b>	PA
<b>Operating voltage</b>	10...30 VDC	<b>Ambient temperature</b>	-25...+70 °C
<b>Quality active face</b>	PA		

## Types and Data – Selection table

Type	ID number	Switching distance [mm]	Housing designation	Output function	Protection class	Output function	Dimensions [mm]
BCT5-S18-UN6X2-H1151	2101400	7.5	M18 × 1	NPN	IP67/IP69K	NO/NC programmable, NPN	18 x 87.3
BCT5-S18-UP6X2-H1151	2101300	7.5	M18 × 1	PNP	IP67/IP69K	NO/NC programmable, PNP	18 x 87.3
BCT10-S30-UN6X2T-H1151	2101600	15	M30 × 1.5	NPN	IP67	NO/NC programmable, NPN	30 x 87.3
BCT10-S30-UP6X2T-H1151	2101500	15	M30 × 1.5	PNP	IP67	NO/NC programmable, PNP	30 x 87.3
BCT10-S30-UN6X2-H1151	2101800	15	M30 × 1.5	NPN	IP67/IP69K	NO/NC programmable, NPN	30 x 87.3
BCT5-S18-UN6X2T-H1151	2101200	7.5	M18 × 1	NPN	IP67	NO/NC programmable, NPN	18 x 87.3
BCT10-S30-UP6X2-H1151	2101700	15	M30 × 1.5	PNP	IP67/IP69K	NO/NC programmable, PNP	30 x 87.3
BCT5-S18-UP6X2T-H1151	2101100	7.5	M18 × 1	PNP	IP67	NO/NC programmable, PNP	18 x 87.3

# Ultrasonic Sensors



The ultrasonic sensors of the RU series offer universal possibilities to adjust and adapt to the toughest application conditions. It is possible to operate them in diffuse, retroreflective or opposed mode, as well as synchronize several sensors to prevent mutual interference. Via IO-Link, process values can be transmitted directly or settings changed on demand during operation. The presence of the objects is typically signaled via the switching output and the distance via the analog output. Highest accuracies are possible through a customizable temperature compensation. Variants for operation in hazardous areas are also available.

## Features

- Application-specific adaptation through temperature compensation
- Preventive maintenance through internal temperature measurement
- Optimization of applications by displaying the signal quality

## Type Code

**RU 600 U - M30 E - LIU2 PN 8 X2 T - H1 1 5 1**

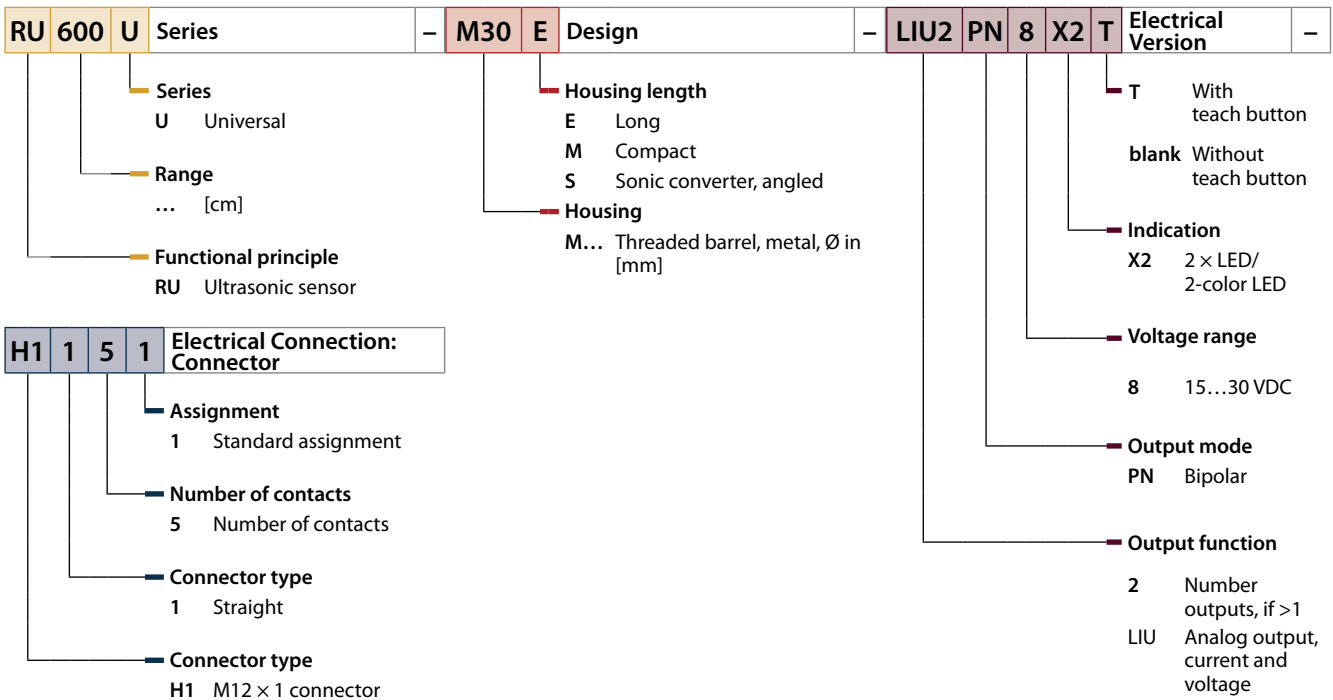

## High-End



General data			
Communication Mode	COM 2 (38.4 kBaud)	IO-Link Specification	V 1.1
IO-Link port type	Class A	Operating mode	Ultrasonic diffuse mode sensor

### Types and Data – Selection table

Type	ID number	Dimensions [mm]	Range [cm]
RU40U-M18E-LIU2PN8X2T-H1151	1610024	18 x 90	2.5...40
RU40U-M18ES-LIU2PN8X2T-H1151	1610025	18 x 107	2.5...40
RU130U-M18E-LIU2PN8X2T-H1151	1610026	18 x 90	15...130
RU130U-M18ES-LIU2PN8X2T-H1151	1610027	18 x 107	15...130
RU130U-M30E-LIU2PN8X2T-H1151	1610046	30 x 89	15...130
RU300U-M30E-LIU2PN8X2T-H1151	1610048	30 x 89	30...300
RU600U-M30E-LIU2PN8X2T-H1151	1610049	44.7 x 104.3	60...600

## Compact



General data			
Communication Mode	COM 2 (38.4 kBaud)	IO-Link Specification	V 1.1
IO-Link port type	Class A	Operating mode	Ultrasonic diffuse mode sensor

### Types and Data – Selection table

Type	ID number	Dimensions [mm]	Range [cm]
RU40U-M18M-AP8X2-H1151	1610094	18 x 63	2.5...40
RU40U-M18MS-AP8X2-H1151	1610105	18 x 80	2.5...40
RU100U-M18M-AP8X2-H1151	1610095	18 x 63	15...100
RU100U-M18MS-AP8X2-H1151	1610106	18 x 80	15...100

# Measuring Light Screens



The measuring light screen EZ-Array offers customized solutions for applications such as the size and profile measurement of products during operation, but also for edge and center guidance, sag control, hole detection and parts counting. The two-piece transmitter-receiver construction facilitates commissioning. The evaluation electronics is integrated in the receiver housing. With the included T-splitter, transmitter and receiver are synchronized and the whole system is connected to the IO-Link master.

## Features

- Robust aluminum housing
- Protection class IP65
- Operating temperature -40 °C...+70 °C
- Resolution 5 mm
- Range max. 4 m
- Scan field 150...2400 mm

## Type Code

**EA5 R 1500 P I XMOD Q**

<b>EA5</b> Series	<b>R</b> Operating Mode	<b>1500</b> Field Range
<b>Series</b> EA5 Measuring light screen, width: 36 mm, depth: 45.2 mm height depending on the type	<b>Operating Mode</b> R Receiver E Emitter	<b>Field Range</b> 150 150 mm 300 300 mm 450 450 mm 600 600 mm 750 750 mm 900 900 mm 1050 1050 mm 1200 1200 mm 1500 1500 mm 1800 1800 mm 2100 2100 mm 2400 2400 mm

<b>P</b> Switching Output (2 ×)	<b>I</b> Analog Output	<b>XMOD</b>
<b>Switching Output</b> Blank PNP (1 ×) P PNP (2 ×) N NPN (2 ×)	<b>Analog Output</b> Blank No analog output I 4...20 mA (2 ×) U 0...10 VDC (2 ×)	<b>XMOD</b> RS485 serial interface (Modbus RTU) via M12 × 1, 5-pin connector (receiver only) <b>XK</b> PNP switching output or IO-Link <b>Blank</b> No output function

<b>Q</b> Electrical Connection
<b>Electrical Connection</b> Q M12 × 1 connector 8-pin

Light Screen EZ-Array – Emitter



General data			
Communication Mode	COM 2 (38.4 kBaud)	IO-Link Specification	V 1.0
IO-Link port type	Class A	Operating mode	Light screen

Types and Data – Selection table

Type	ID number	Dimensions [mm]	Scan field [mm]
EA5R150XKQ	3015151	45.2 x 36 x 227	150
EA5R300XKQ	3015152	45.2 x 36 x 379	300
EA5R450XKQ	3015155	45.2 x 36 x 529	450
EA5R600XKQ	3015156	45.2 x 36 x 678	600
EA5R750XKQ	3015157	45.2 x 36 x 828	750
EA5R900XKQ	3015158	45.2 x 36 x 978	900
EA5R1050XKQ	3015171	45.2 x 36 x 1128	1050
EA5R1200XKQ	3015172	45.2 x 36 x 1278	1200

Light Screen EZ-Array – Receiver



General data			
Light type	IR	Operating mode	Light screen

Types and Data – Selection table

Type	ID number	Dimensions [mm]	Scan field [mm]
EA5E150Q	3075423	45.2 x 36 x 227	150
EA5E300Q	3075424	45.2 x 36 x 379	300
EA5E450Q	3075425	45.2 x 36 x 529	450
EA5E600Q	3075426	45.2 x 36 x 678	600
EA5E750Q	3075427	45.2 x 36 x 828	750
EA5E900Q	3075428	45.2 x 36 x 978	900
EA5E1050Q	3075429	45.2 x 36 x 1128	1050
EA5E1200Q	3075430	45.2 x 36 x 1278	1200

# Inductive Linear Position Sensors



The inductive linear position sensors operate without contact and wear-free thanks to a revolutionary measuring principle. The position is not detected via a positioning magnet but via an oscillating RLC circuit. IO-Link is used, in addition to the digital transmission of process data, also for application-specific adaptation, for example by setting the measuring range.

## Features

- Wear-free signal detection
- Reduced failure rate through inductive technology
- High signal accuracy with IO-Link
- High insensitivity to magnetic fields

## Type Code

**Li 100 P1 - Q25L M1 - E LiUPN8 X3 - H1 1 5 1**

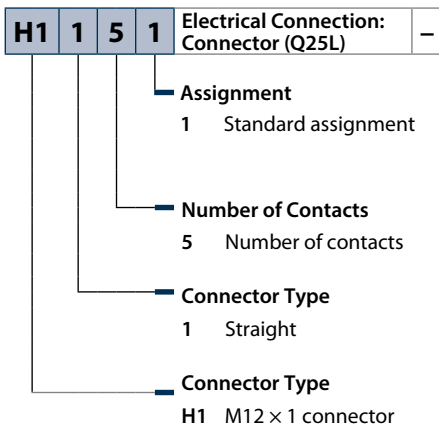
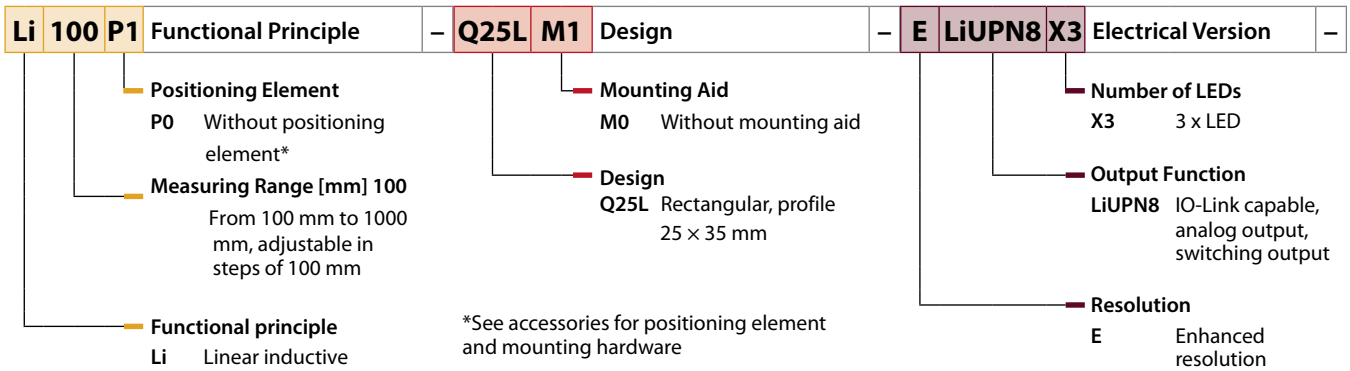

## Inductive Linear Position Sensors LI

### General data

IO-Link Specification

IO-Link specified acc.  
to version 1.0



### Types and Data – Selection table

Type	ID number	Measuring range	Resolution	Dimensions [mm]
LI100P0-Q25LM0-ELIUPN8X3-H1151	1590017	100	0.002 mm/16 bit	158 x 35 x 25
LI200P0-Q25LM0-ELIUPN8X3-H1151	1590604	200	0.003 mm/16 bit	258 x 35 x 25
LI300P0-Q25LM0-ELIUPN8X3-H1151	1590018	300	0.005 mm/16 bit	358 x 35 x 25
LI400P0-Q25LM0-ELIUPN8X3-H1151	1590605	400	0.006 mm/16 bit	458 x 35 x 25
LI500P0-Q25LM0-ELIUPN8X3-H1151	1590606	500	0.008 mm/16 bit	558 x 35 x 25
LI600P0-Q25LM0-ELIUPN8X3-H1151	1590607	600	0.009 mm/16 bit	658 x 35 x 25
LI700P0-Q25LM0-ELIUPN8X3-H1151	1590608	700	0.011 mm/16 bit	758 x 35 x 25
LI800P0-Q25LM0-ELIUPN8X3-H1151	1590609	800	0.012 mm/16 bit	858 x 35 x 25
LI900P0-Q25LM0-ELIUPN8X3-H1151	1590610	900	0.014 mm/16 bit	958 x 35 x 25
LI1000P0-Q25LM0-ELIUPN8X3-H1151	1590611	1000	0.015 mm/16 bit	1058 x 35 x 25

For more details on mounting aids and positioning elements see chapter "Accessories"

## Inductive Linear Position Sensors – Accessories

### P1-LI-Q25L

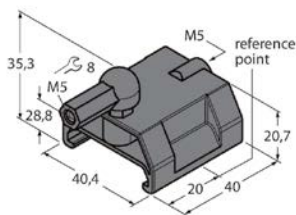

Guided positioning element for Li-Q25L, inserted in the sensor guide.

### P2-LI-Q25L

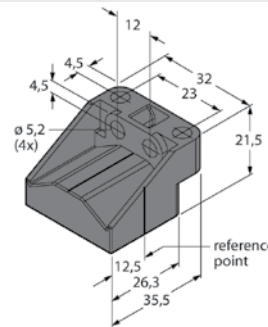

Floating positioning element for Li-Q25L; the nominal distance to the sensor is 1.5 mm; pairing with the linear position sensor at a distance of up to 5 mm or misalignment tolerance of up to 4 mm.

# Encoders and Inclinometers



The contactless operating encoder Ri-QR24 makes no compromise in terms of robustness and tightness. A mechanical coupling between the sensor and the machine shaft is – in contrast to conventional rotary encoders – no longer required. With IO-Link the measuring signal can be inexpensively and effectively evaluated and also the zero point of a measurement set.

The inclinometer B2N360-Q42 delivers angle information for two axes via 2 x 16 bits in the IO-Link telegram. With low-pass filters, which are available via IO-Link, the sensor can be exactly adapted to the application.

## Features

- Wear-free rotation monitoring through inexpensive encoder with additional functions
- 360-degree inclination and acceleration measurement with precise application setting and high resolution measuring signal
- Flexible adjustment with IO-Link

## Type Code

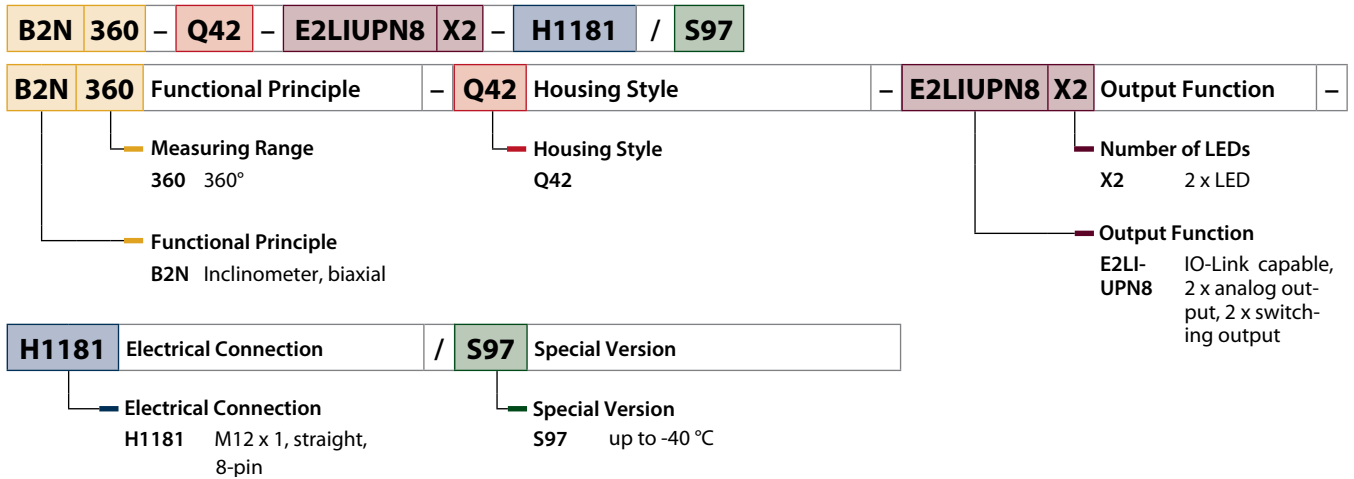
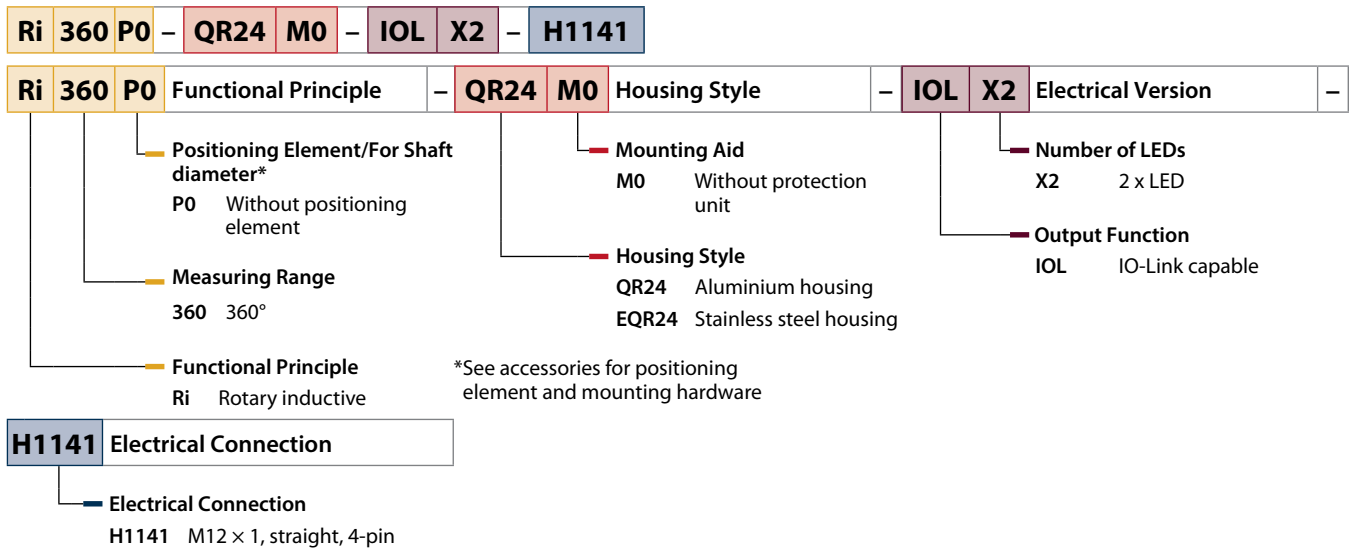



Encoder QR24

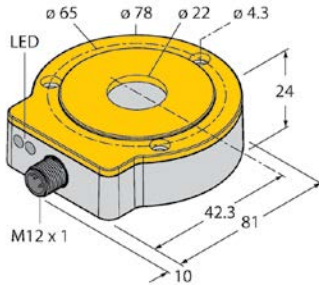

General data			
<b>Electrical connection</b>	Connector, M12, 4-pin	<b>Output function</b>	IO-Link
<b>Operating voltage</b>	15...30 VDC	<b>Ambient temperature</b>	-25...+85 °C
<b>Protection class</b>	IP68/IP69K	<b>Dimensions [mm]</b>	81 x 78 x 24
<b>Housing material</b>	ZnAlCu1/PBT-GF30-V0		

Types and Data – Selection table

Type	ID number
RI360P0-QR24M0-IOLX2-H1141	1590975
RI360P0-EQR24M0-IOLX2-H1141	1590978

Encoders – Accessories

P1-RI-QR24

Positioning element, for Ø 20 mm shafts

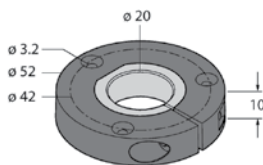

P2-RI-QR24

Positioning element, for Ø 14 mm shafts

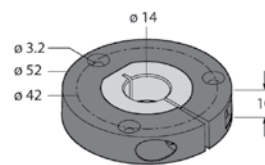

Inclinometer B2N-Q42



General data			
<b>Electrical connection</b>	Connector, M12 x 1	<b>Operating current</b>	150 DC
<b>Description</b>	Rectangular, plastic	<b>Housing material</b>	PA12-GF30
<b>Housing designation</b>	Q42	<b>Output function</b>	NO/NC, PNP/NPN, analog output, IO-Link
<b>Protection class</b>	IP68/IP69K	<b>Dimensions [mm]</b>	67.5 x 42.5 x 42.5

Types and Data – Selection table

Type	ID number	Operating voltage [VDC]	Ambient temperature [°C]
B2N360-Q42-E2LIUPN8X2-H1181	1534116	15...30	-25...+85
B2N360-Q42-E2LIUPN8X2-H1181/S97	1534117	7...30	-40...+85

# Pressure Sensors



The pressure sensors of the PS and PC series impress with their variety of process connections and excellent robustness. Thanks to rotatable sensor bodies and a selection of different pressure ranges the sensors can be used flexibly. Via IO-Link, the pressure ranges and other parameters can be set both during commissioning as well as during operation. The comprehensive diagnostic functions of the devices provide many preventive maintenance relevant information on the application.

## Features

- PS series: pressure sensor with display
- PC series: compact pressure transmitter without display
- Robust housings for harsh environments
- Simplified commissioning through IO-Link

## Type Code

**PC 250R - 2 01 - 2UPN 8 X - H1 1 4 1**

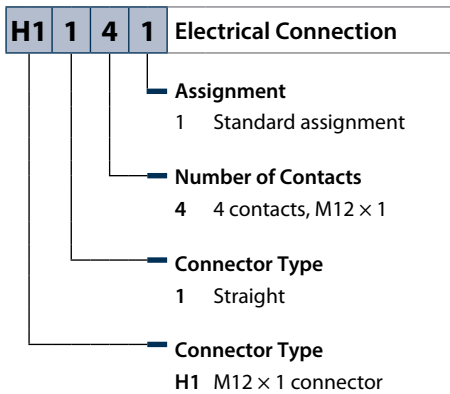
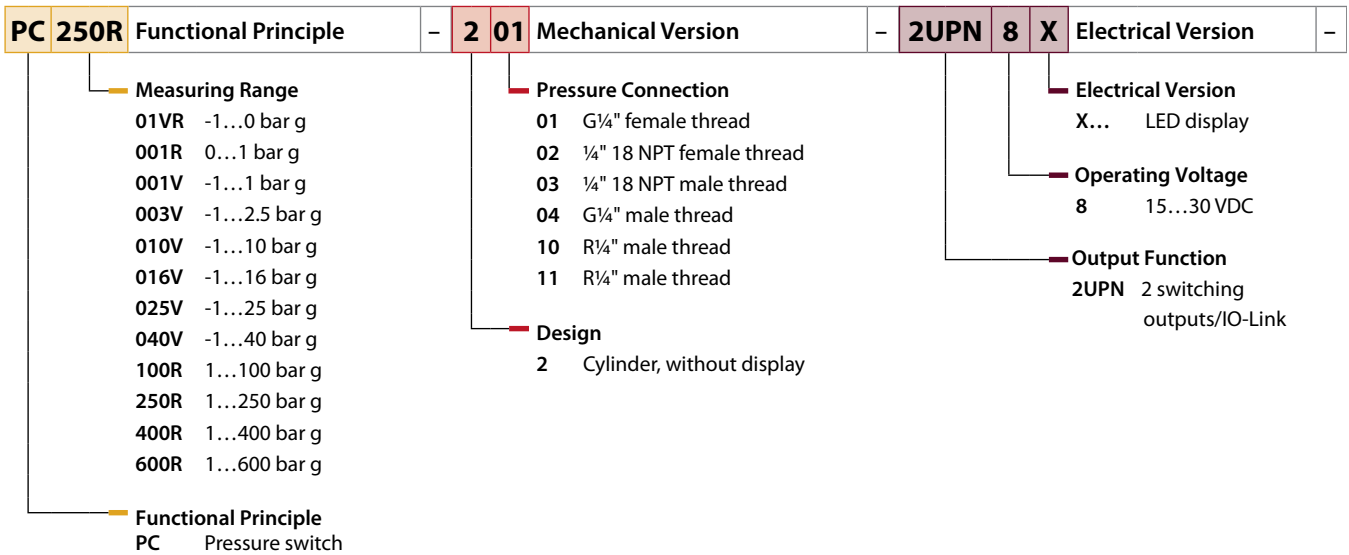

**PS 010V - 5 01 - LI2UPN 8 X - H1 1 4 1 / 3GD**

**PS 010V Functional Principle - 5 01 Mechanical Version - LI2UPN 8 X Electrical Version -**

- Measuring Range**
  - 01VR -1...0 bar g<sup>1)</sup>
  - 001R 0...1 bar g<sup>1)</sup>
  - 001V -1...1 bar g<sup>1)</sup>
  - 003V -1...2.5 bar g<sup>1)</sup>
  - 010V -1...10 bar g
  - 016V -1...16 bar g
  - 025V -1...25 bar g
  - 040V -1...40 bar g
  - 100R 0...100 bar g
  - 250R 0...250 bar g
  - 400R 0...400 bar g
  - 600R 0...600 bar g<sup>2)</sup>
- Functional Principle**
  - PS Pressure sensor

- Process Connection**
  - 01 G1/4" female thread
  - 02 1/4"-18NPT female thread
  - 03 1/4"-18NPT male thread
  - 04 G1/4" male thread
  - 05 7/16" UNF male thread (only for design 6)
  - 06 G3/4" male thread front-flush (only for design 6)
  - 07 1 1/2" Tri-Clamp (only for design 6)
  - 08 G1/4" male thread manometer connection (only for design 5)
  - 09 G1/2" male thread front-flush (only for design 6)
  - 10 R 1/4" male thread
  - 11 R 1/4" female thread

- Design**
  - 3 With display, non-rotatable
  - 5 With display, rotatable
  - 6 With display, non-rotatable, With front-flush membrane

- Indication**
  - X... LED display
- Voltage Range**
  - 8 15 (18)...30 VDC
- Output Function**
  - 2UPN 2 switching outputs/IO-Link
  - LUUPN Voltage and switching output/IO-Link
  - LI2UPN Current and switching output/IO-Link

<sup>1)</sup> Not available for design/pressure connection 609  
<sup>2)</sup> Not available for design 6

g = Relative pressure  
a = Absolute pressure

**H1 1 4 1 Electrical Connection: Connector / 3GD Approval**

- Assignment**
  - 1 Standard assignment
- Number of Contacts**
  - 4 4 Contacts
- Connector Type**
  - 1 Straight
- Approval**
  - 3GD ATEX II3G and II3D
- Connector Type**
  - H1 M12 × 1 connector

## Pressure Sensor PC Series without Display



## General data

<b>Electrical connection</b>	Connector, M12 × 1	<b>Housing material</b>	1.4305 (AISI 303)/ PBT-GF15
<b>Operating voltage</b>	15...30 VDC	<b>Output function</b>	NO/NC, PNP/NPN
<b>Protection class</b>	IP69K		

## Types and Data – Selection table

Type	ID number	Operating range (min.)	Operating range (max.)	Process connection
PC01VR-201-2UPN8X-H1141	6833713	-1 bar rel.	0 bar rel.	G¼" female thread
PC001V-201-2UPN8X-H1141	6833714	-1 bar rel.	1 bar rel.	G¼" female thread
PC010V-201-2UPN8X-H1141	6833717	-1 bar rel.	10 bar rel.	G¼" female thread
PC025V-201-2UPN8X-H1141	6833719	-1 bar rel.	25 bar rel.	G¼" female thread
PC001R-201-2UPN8X-H1141	6833715	0 bar rel.	1 bar rel.	G¼" female thread
PC016V-201-2UPN8X-H1141	6833718	-1 bar rel.	16 bar rel.	G¼" female thread
PC003V-201-2UPN8X-H1141	6833716	-1 bar rel.	2.5 bar rel.	G¼" female thread
PC400R-201-2UPN8X-H1141	6833723	0 bar rel.	400 bar rel.	G¼" female thread
PC600R-201-2UPN8X-H1141	6833724	0 bar rel.	600 bar rel.	G¼" female thread
PC040V-201-2UPN8X-H1141	6833720	-1 bar rel.	40 bar rel.	G¼" female thread
PC100R-201-2UPN8X-H1141	6833721	0 bar rel.	100 bar rel.	G¼" female thread
PC250R-201-2UPN8X-H1141	6833722	0 bar rel.	250 bar rel.	G¼" female thread
PC01VR-202-2UPN8X-H1141	6833725	-1 bar rel.	0 bar rel.	NPT ¼"-18 female thread
PC001V-202-2UPN8X-H1141	6833726	-1 bar rel.	1 bar rel.	NPT ¼"-18 female thread
PC001R-202-2UPN8X-H1141	6833727	0 bar rel.	1 bar rel.	NPT ¼"-18 female thread
PC003V-202-2UPN8X-H1141	6833728	-1 bar rel.	2.5 bar rel.	NPT ¼"-18 female thread
PC010V-202-2UPN8X-H1141	6833729	-1 bar rel.	10 bar rel.	NPT ¼"-18 female thread
PC016V-202-2UPN8X-H1141	6833730	-1 bar rel.	16 bar rel.	NPT ¼"-18 female thread
PC025V-202-2UPN8X-H1141	6833731	-1 bar rel.	25 bar rel.	NPT ¼"-18 female thread
PC040V-202-2UPN8X-H1141	6833732	-1 bar rel.	40 bar rel.	NPT ¼"-18 female thread
PC100R-202-2UPN8X-H1141	6833733	0 bar rel.	100 bar rel.	NPT ¼"-18 female thread
PC250R-202-2UPN8X-H1141	6833734	0 bar rel.	250 bar rel.	NPT ¼"-18 female thread
PC400R-202-2UPN8X-H1141	6833735	0 bar rel.	400 bar rel.	NPT ¼"-18 female thread
PC600R-202-2UPN8X-H1141	6833736	0 bar rel.	600 bar rel.	NPT ¼"-18 female thread
PC01VR-204-2UPN8X-H1141	6833749	-1 bar rel.	0 bar rel.	G¼" male thread
PC001V-204-2UPN8X-H1141	6833750	-1 bar rel.	1 bar rel.	G¼" male thread
PC001R-204-2UPN8X-H1141	6833751	0 bar rel.	1 bar rel.	G¼" male thread
PC003V-204-2UPN8X-H1141	6833752	-1 bar rel.	2.5 bar rel.	G¼" male thread
PC010V-204-2UPN8X-H1141	6833753	-1 bar rel.	10 bar rel.	G¼" male thread
PC016V-204-2UPN8X-H1141	6833754	-1 bar rel.	16 bar rel.	G¼" male thread
PC025V-204-2UPN8X-H1141	6833755	-1 bar rel.	25 bar rel.	G¼" male thread
PC040V-204-2UPN8X-H1141	6833756	-1 bar rel.	40 bar rel.	G¼" male thread
PC100R-204-2UPN8X-H1141	6833757	0 bar rel.	100 bar rel.	G¼" male thread
PC250R-204-2UPN8X-H1141	6833758	0 bar rel.	250 bar rel.	G¼" male thread
PC400R-204-2UPN8X-H1141	6833759	0 bar rel.	400 bar rel.	G¼" male thread

## Pressure Sensor PS Series with Display



### General data

<b>Electrical connection</b>	Connector, M12 × 1	<b>Housing material</b>	V2A (1.4305)
<b>Operating voltage</b>	18...30 VDC	<b>Output function</b>	NO/NC, PNP/NPN
<b>Protection class</b>	IP67/IP69K		

### Types and Data – Selection table

Type	ID number	Operating range (min.)	Operating range (max.)	Process connection
PS01VR-501-2UPN8X- H1141	6832624	-1 bar rel.	0 bar rel.	G $\frac{1}{4}$ " female thread
PS001R-501-2UPN8X- H1141	6832625	0 bar rel.	1 bar rel.	G $\frac{1}{4}$ " female thread
PS016V-501-2UPN8X- H1141	6832629	-1 bar rel.	16 bar rel.	G $\frac{1}{4}$ " female thread
PS010V-501-2UPN8X- H1141	6832628	-1 bar rel.	10 bar rel.	G $\frac{1}{4}$ " female thread
PS003V-501-2UPN8X- H1141	6832627	-1 bar rel.	2.5 bar rel.	G $\frac{1}{4}$ " female thread
PS001V-501-2UPN8X- H1141	6832626	-1 bar rel.	1 bar rel.	G $\frac{1}{4}$ " female thread
PS001A-501-2UPN8X- H1141	6832636	0 bar rel.	1 bar rel.	G $\frac{1}{4}$ " female thread
PS400R-501-2UPN8X- H1141	6832634	0 bar rel.	400 bar rel.	G $\frac{1}{4}$ " female thread
PS003A-501-2UPN8X- H1141	6832637	0 bar rel.	3 bar rel.	G $\frac{1}{4}$ " female thread
PS010A-501-2UPN8X- H1141	6832638	0 bar rel.	10 bar rel.	G $\frac{1}{4}$ " female thread
PS025V-501-2UPN8X- H1141	6832630	-1 bar rel.	25 bar rel.	G $\frac{1}{4}$ " female thread
PS100R-501-2UPN8X- H1141	6832632	0 bar rel.	100 bar rel.	G $\frac{1}{4}$ " female thread
PS250R-501-2UPN8X- H1141	6832633	0 bar rel.	250 bar rel.	G $\frac{1}{4}$ " female thread
PS040V-501-2UPN8X- H1141	6832631	-1 bar rel.	40 bar rel.	G $\frac{1}{4}$ " female thread
PS016A-501-2UPN8X- H1141	6832639	0 bar rel.	16 bar rel.	G $\frac{1}{4}$ " female thread
PS600R-501-2UPN8X- H1141	6832635	0 bar rel.	600 bar rel.	G $\frac{1}{4}$ " female thread
PS016V-606-2UPN8X- H1141	6833059	-1 bar rel.	16 bar rel.	G $\frac{3}{4}$ " front-flush
PS010V-606-2UPN8X- H1141	6833058	-1 bar rel.	10 bar rel.	G $\frac{3}{4}$ " front-flush
PS003V-606-2UPN8X- H1141	6833057	-1 bar rel.	2.5 bar rel.	G $\frac{3}{4}$ " front-flush
PS01VR-606-2UPN8X- H1141	6833054	-1 bar rel.	0 bar rel.	G $\frac{3}{4}$ " front-flush
PS001V-606-2UPN8X- H1141	6833056	-1 bar rel.	1 bar rel.	G $\frac{3}{4}$ " front-flush
PS001R-606-2UPN8X- H1141	6833055	0 bar rel.	1 bar rel.	G $\frac{3}{4}$ " front-flush
PS100R-606-2UPN8X- H1141	6833062	0 bar rel.	100 bar rel.	G $\frac{3}{4}$ " front-flush
PS250R-606-2UPN8X- H1141	6833063	0 bar rel.	250 bar rel.	G $\frac{3}{4}$ " front-flush
PS400R-606-2UPN8X- H1141	6833064	0 bar rel.	400 bar rel.	G $\frac{3}{4}$ " front-flush
PS040V-606-2UPN8X- H1141	6833061	-1 bar rel.	40 bar rel.	G $\frac{3}{4}$ " front-flush
PS025V-606-2UPN8X- H1141	6833060	-1 bar rel.	25 bar rel.	G $\frac{3}{4}$ " front-flush

# Temperature Sensors



Temperature sensors of the TS series are robustly designed in stainless steel and have a rotatable display. For temperature measurement TP thermocouples are connected via a standard M12 connector. The TTM temperature transmitters are devices without display that can be installed in any position in the system. Via IO-Link measured values can be transmitted as well as identification data; thus also the location can be determined. In addition, IO-Link offers advanced options for configuration and diagnostics.

## Features

- Easy handling
- Peak memory for better maintenance
- IO-Link for commissioning and process-dependent settings

## Type Code

**TS** - **5** **00** - **LI2UPN** **8** **X** - **H1** **1** **4** **1**

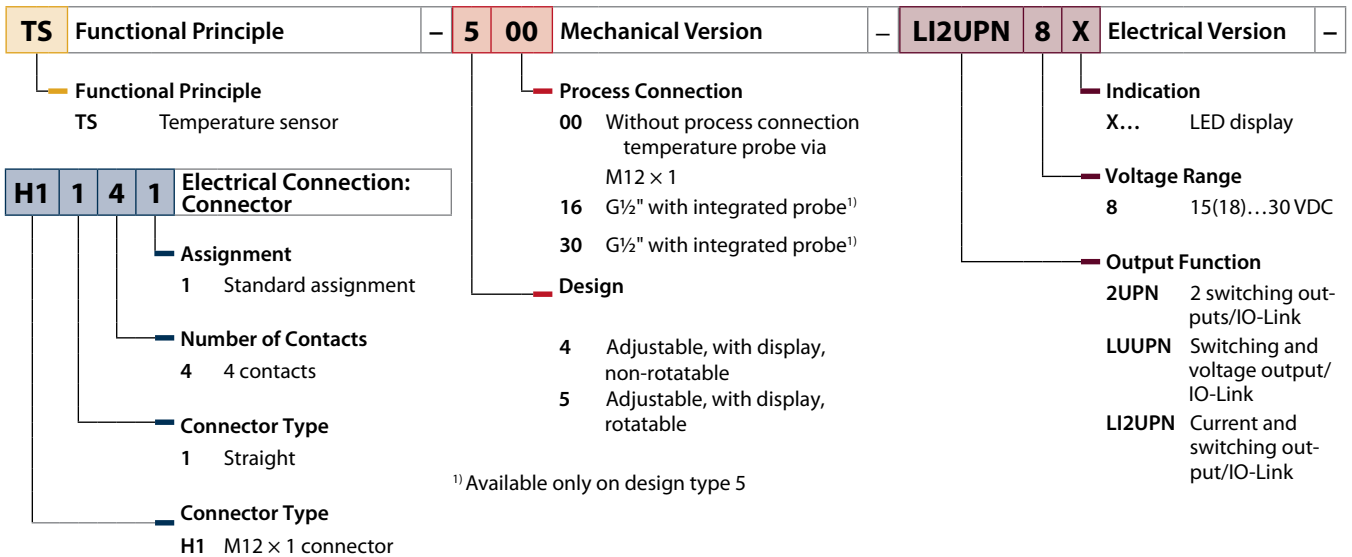

**TTM** - **100C** - **203A** - **CF** - **LIUPN** - **H1 1 4 0** - **L100**

**TTM** Functional Principle - **100C** Measuring Range - **203A** Design -

**Type**

- TTM** Temperature transmitter, miniature
- TTMS** Temperature transmitter, miniature, stainless steel

**Measuring range**

- ...
- Blank** Freely adjustable via IO-Link

**Design**

- 100** Processor unit without probe
- 103A** Processor unit with probe Ø 3 mm, process connection via standard thread, accuracy class A
- 203A** For assembly with compression fitting/thermowell, probe Ø 3 mm, accuracy class A
- 206A** For assembly with compression fitting/thermowell, probe Ø 6

**CF** Process Connection - **LIUPN** Electrical Output -

**Process Connection**

- G1/8** G1/8" male thread (only 103A)
- CF** Compression fitting (only 203A and 206A)
- Blank** Probe via M12 connector

**Electrical output**

- LIUPN** 4...20 mA, 2-wire, switching output/IO-Link

**H1 1 4 0** Electrical Connection: Connector - **L100** Insertion Depth

**Assignment**

- 0** Special assignment: Pin 1: +, Pin 2: -

**Number of Contacts**

- 4** 4 contacts

**Connector Type**

- 1** Straight

**Connector Type**

- H1** M12 × 1 connector

**Probe Length in mm**

- L013** 13 mm (only 103A)
- L024** 24 mm (only 103A)
- L100** 100 mm
- L150** 150 mm
- Special lengths on request!**

## Temperature Sensor TS Series with Display



## General data

<b>Electrical connection</b>	Connector, M12 × 1	<b>Housing material</b>	V2A (1.4305)
<b>Operating voltage</b>	18...30 VDC		

## Types and Data – Selection table

Type	ID number	Protection class	Output function	Rod length [mm]	Measuring element	Process connection
TS-516-LI2UPN8X-H1141-L050	6840028	IP67/IP69K	NO/NC programmable, 4-wire	50	Pt-100 probe, DIN EN 60751, class A	G ½" male thread
TS-516-LI2UPN8X-H1141-L016	6840026	IP67/IP69K	NO/NC programmable, 4-wire	16	Pt-100 probe, DIN EN 60751, class A	G ½" male thread
TS-500-LI2UPN8X-H1141	6840015	IP67	NO/NC programmable, PNP/NPN		For connection to probes of the TP series	Cylindrical, Ø 18 mm
TS-400-LI2UPN8X-H1141	6840007	IP67	NO/NC programmable, PNP/NPN		For connection to probes of the TP series	Cylindrical, Ø 18 mm

## Temperature Sensor TTM Series without Display

## General data

<b>Mounting conditions</b>	Immersion sensor	<b>Protection class</b>	IP67
<b>Electrical connection</b>	Connector, M12 × 1	<b>Housing material</b>	V4A (1.4404)
<b>Operating voltage</b>	15...30 VDC		



## Types and Data – Selection table

Type	ID number	Output function	Rod length [mm]	Measuring element	Process connection
TTM-103A-G1/8-LIUPN-H1140-L013	9910628	NO/NC programmable, PNP/NPN	13	Pt-100 probe, DIN EN 60751, class A	G1/8" male thread
TTM-206A-CF-LIUPN-H1140-L150	9910626	NO/NC programmable, PNP/NPN	150	Pt-100 probe, DIN EN 60751, class A	For compression fittings, thermowell or direct mounting
TTM-203A-CF-LIUPN-H1140-L100	9910620	NO/NC programmable, PNP/NPN	100	Pt-100 probe, DIN EN 60751, class A	For compression fittings, thermowell or direct mounting
TTM-206A-CF-LIUPN-H1140-L100	9910624	NO/NC programmable, PNP/NPN	100	Pt-100 probe, DIN EN 60751, class A	For compression fittings, thermowell or direct mounting
TTM-203A-CF-LIUPN-H1140-L150	9910622	NO/NC programmable, PNP/NPN	150	Pt-100 probe, DIN EN 60751, class A	For compression fittings, thermowell or direct mounting
TTM-103A-G1/8-LIUPN-H1140-L024	9910630	NO/NC programmable, PNP/NPN	24	Pt-100 probe, DIN EN 60751, class A	G1/8" male thread



Type	ID number	Output function	Rod length [mm]	Measuring element	Process connection
TTMS-203A-CF-LIUPN-H1140-L150	9910658	NO/NC programmable, 4-wire	150	Pt-100 probe, DIN EN 60751, class A	For compression fittings, thermowell or direct mounting
TTMS-203A-CF-LIUPN-H1140-L100	9910656	NO/NC programmable, 4-wire	100	Pt-100 probe, DIN EN 60751, class A	For compression fittings, thermowell or direct mounting
TTMS-103A-G1/8-LIUPN-H1140-L024	9910652	NO/NC programmable, 4-wire	24	Pt-100 probe, DIN EN 60751, class A	G1/8" male thread
TTMS-100-LIUPN-H1140	9910654	NO/NC programmable, PNP/NPN		For connection to probes of the TP series	M12 × 1
TTMS-103A-G1/8-LIUPN-H1140-L013	9910650	NO/NC programmable, 4-wire	13	Pt-100 probe, DIN EN 60751, class A	G1/8" male thread
TTMS-206A-CF-LIUPN-H1140-L100	9910660	NO/NC programmable, 4-wire	100	Pt-100 probe, DIN EN 60751, class A	For compression fittings, thermowell or direct mounting
TTMS-206A-CF-LIUPN-H1140-L150	9910662	NO/NC programmable, 4-wire	150	Pt-100 probe, DIN EN 60751, class A	For compression fittings, thermowell or direct mounting

# Flow Sensors



The flow modules of the FM series combine ease of operation and high functionality with a variety of connections and thus cover all the requirements of efficient flow monitoring. The large number of usable probes enables continuous flow monitoring for a precise fine tuning of the processes. Thanks to IO-Link, the user saves more analog interfaces in the cabinet and has the possibility to adapt the module to its application.

## Features

- Communication-capable cabinet module
- Undisturbed transmission of measured values via IO-Link
- Versatile sensor elements

## Type Code

**FM X - IM - 3UP 63 X**

FM	X	Series/Functions	-	IM	Design	-	3UP	63	X	Electrical Version
		<p><b>Functions</b></p> <p><b>Blank</b> Connection of non-Ex sensors of the type FCS-/FCI-...-NA, FM series is IO-Link capable</p> <p><b>X</b> Connection of Ex sensors of the type FCS-/FCI-...-NAEX(0), FMX series is IO-Link capable</p> <p><b>Series</b></p> <p><b>FM</b> Flow module, processing unit for the connection of Turck flow sensors</p>		<p><b>Design</b></p> <p><b>IM</b> Interface module (modular housing)</p>			<p><b>LED Display</b></p> <p><b>X</b> 4 status LEDs, LED band</p> <p><b>Voltage Range</b></p> <p><b>38</b> 20...125 VDC/ 20...250 VAC</p> <p><b>63</b> 20...30 VDC</p> <p><b>Output Function</b></p> <p><b>3UP</b> One PNP output (20...30 VDC) each for flow, temperature and error monitoring</p> <p><b>3UR</b> One relay output (&lt; 250 VAC/60 VDC) each for flow, temperature and error monitoring</p> <p><b>2UPLi</b> One PNP output (20...30 VDC) each for temperature and error monitoring and one analog output (4...20 mA) for flow monitoring</p>			

Signal Processors



**General data**

<b>Electrical connection</b>	Terminal block	<b>Dimensions</b>	110 x 27 x 89 mm
------------------------------	----------------	-------------------	------------------

**Types and Data – Selection table**

Type	ID number	Operating voltage [VDC]	Output function	Application area
FM-IM-3UR38X	7525102	20...125	NO/NC programmable, Relay output	Standard
FMX-IM-3UR38X	7525103	20...125	NO/NC programmable, Relay output	Explosion hazard (associated equipment)
FM-IM-2UPLI63X	7525104	20...30	4...20 mA, Analog output current	Standard
FM-IM-3UP63X	7525100	20...30	NO/NC programmable, PNP	Standard
FMX-IM-3UP63X	7525101	20...30	NO/NC programmable, PNP	Explosion hazard (associated equipment)
FM-IM-3UP63FX	100000818	20...30	NO/NC programmable, PNP	Standard
FM-IM-2UPLI63FX	100000819	20...30	4...20 mA, Analog output current	Standard
FM-IM-3UR38FX	100000820	20...125	NO/NC programmable, Relay output	Standard
FMX-IM-3UR38FX	100000821	20...125	NO/NC programmable, Relay output	
FMX-IM-3UP63FX	100000822	20...30	NO/NC programmable, PNP	

Immersion Probes – Standard

**General data**

<b>Mounting conditions</b>	Immersion sensor	<b>Application area</b>	Standard
<b>Description</b>	Flow sensor for liquid media		



**Types and Data – Selection table**

Type	ID number	Electrical connection	Protection class	Housing material
FCS-G1/4A4-NA-H1141	6870304	Connector, M12 x 1	IP67	V4A (1.4571)
FCS-G1/2A2-NA	6870309	2 m	IP68	V2A (1.4305)
FCS-G1/2A4-NA	6870338	2 m	IP68	V4A (1.4571)
FCS-N1/2A4-NA-H1141	6871303	Connector, M12 x 1	IP67	V4A (1.4571)
FCS-N3/4A4-NA-H1141	6871304	Connector, M12 x 1	IP67	V4A (1.4571)
FCS-N1/2A4-NA	6871309	2 m, FEP cable	IP68	V4A (1.4571)
FCS-G1/2DY-NA	6870510	2 m, FEP cable	IP68	PVDF

## Immersion Probes – Ex



General data			
<b>Mounting conditions</b>	Immersion sensor	<b>Housing material</b>	V4A (1.4571)
<b>Description</b>	Sensor according to category II 2 G for liquid media	<b>Application area</b>	Explosion hazard (zone 1)
<b>Protection class</b>	IP67		

### Types and Data – Selection table

Type	ID number	Electrical connection
FCS-G1/2A4-NAEX-H1141	6870322	Connector, M12 × 1
FCS-G1/2A4-NAEX	6870320	2 m, PUR cable
FCS-G1/4A4-NAEX-H1141	6870341	Connector, M12 × 1
FCS-N1/2A4-NAEX-H1141	6871322	Connector, M12 × 1

## Inline Probes – Standard



General data			
<b>Mounting conditions</b>	Inline sensor	<b>Protection class</b>	IP67
<b>Electrical connection</b>	Connector, M12 × 1	<b>Housing material</b>	V4A (1.4571)
<b>Description</b>	Flow sensor for liquid media	<b>Application area</b>	Standard

### Types and Data – Selection table

Type	ID number	Mechanical connection
FCI-D03A4-NA-H1141/M16	6870633	M16 × 1.5
FCI-D03A4-NA-H1141/M12	6870635	M12 × 1.5
FCI-D09A4-NA-H1141/M16	6870631	M16 × 1.5

## Inline Probes – Ex



General data			
<b>Mounting conditions</b>	Inline sensor	<b>Protection class</b>	IP67
<b>Electrical connection</b>	Connector, M12 × 1	<b>Housing material</b>	V4A (1.4571)
<b>Description</b>	Sensor according to category II 2 G for liquid media	<b>Application area</b>	Explosion hazard (zone 1)

### Types and Data – Selection table

Type	ID number	Mechanical connection
FCI-D03A4-NAEX-H1141/M12	6870632	M12 × 1.5
FCI-D09A4-NAEX-H1141/M16	6870634	M16 × 1.5

# Laser Sensors



The Q4X sensor with a reach of up to 100 or 300 mm not only measures distances, but also the light intensity. This opens up a wide range of applications for the sensor. The laser sensors of the LE series also use the laser triangulation principle and achieve ranges of up to 1 m at a resolution of up to 0.02 mm. The laser sensors of the LTF12 and LTF24 series work according to the pulse transit time method and achieve long ranges up to 12 or 24 m at a resolution of 0.3 mm. All laser sensors are set via pushbutton on the housing. The integrated display facilitates adjustment and displays the measured distance.

## Features

- Laser class 1 and 2 sensors
- Parameter setting via pushbutton
- Robust housings for harsh environments
- Q4X Series: dual-mode, change of distance and light intensity, ECOLAB certified
- LE series: optical resolution < 0.5 mm, two-line LCD display
- LTF12 Series: Pulse transit time method, large measuring range 0.05...12 m or 0.05...24 m

## Type Code

**Q4XT B LAF 300 Q8**

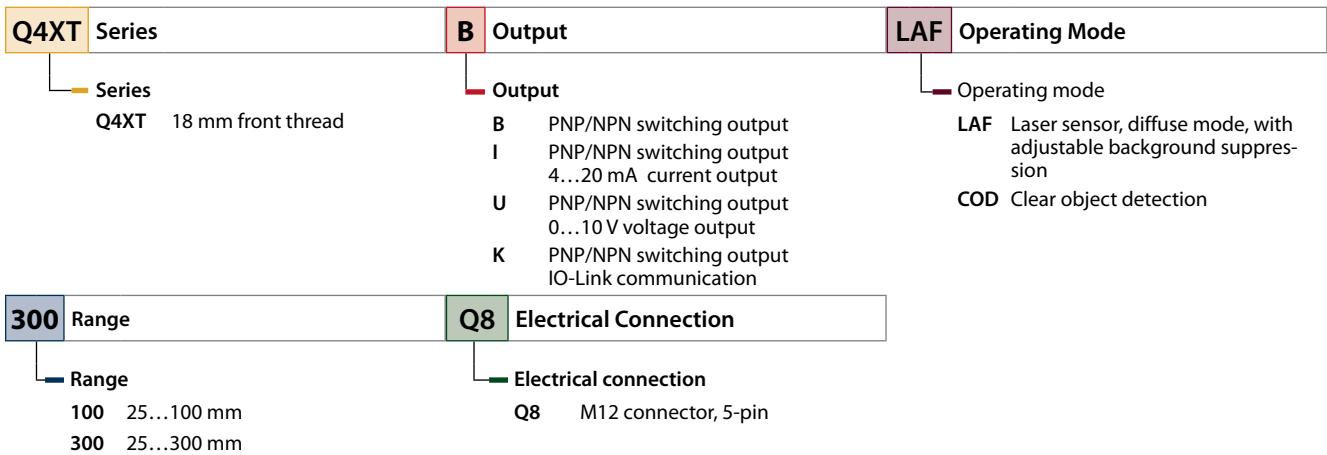

**LTF 12 I C2 LD Q**

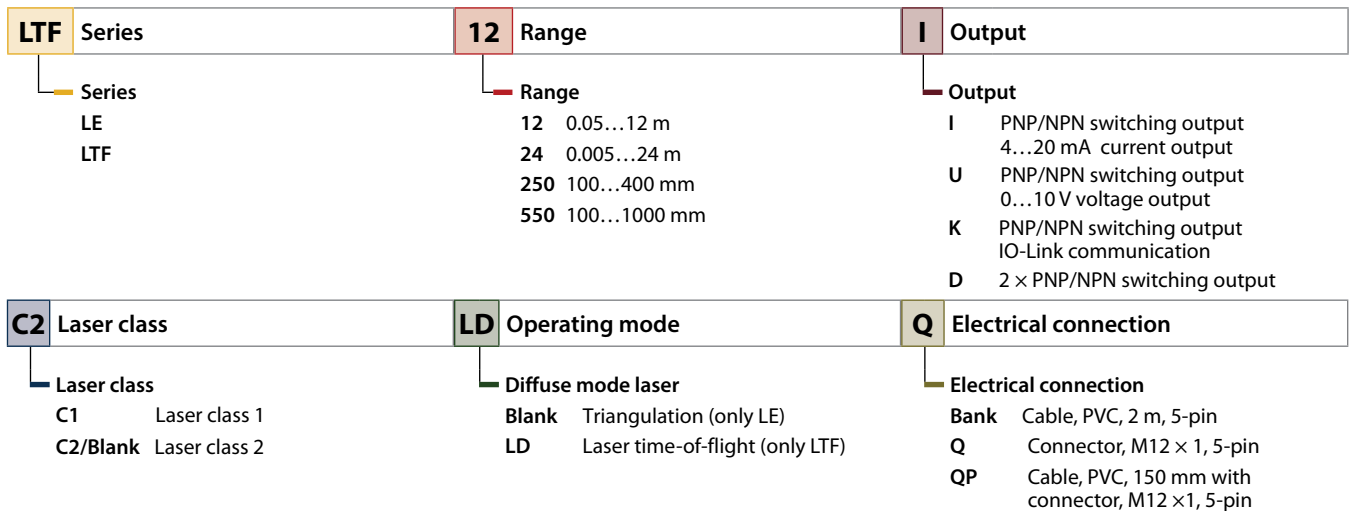

### Laser Sensor Q4X Series



General data			
Communication Mode	COM 2 (38.4 kBaud)	Dimensions	43.5 x 18 x 57.5 mm
IO-Link port type	Class A	Light type	Red
IO-Link Specification	V 1.1		

#### Types and Data – Selection table

Type	ID number
Q4XTKLAF100-Q8	3097071
Q4XTKLAF300-Q8	3095301

### Laser Sensor LE Series



General data			
Communication Mode	COM 2 (38.4 kBaud)	Dimensions	56 x 26 x 77 mm
IO-Link port type	Class A	Light type	Red
IO-Link Specification	V 1.1		

#### Types and Data – Selection table

Type	ID number
LE250KQ	3097763
LE550KQ	3097761

### Laser Sensor LTF Series



General data			
Communication Mode	COM 2 (38.4 kBaud)	Dimensions	77 x 26 x 56 mm
IO-Link port type	Class A	Light type	Red
IO-Link Specification	V 1.1		

#### Types and Data – Selection table

Type	ID number
LTF12KC2LDQ	3801130
LTF24KC2LDQ	3803280

# Clear Object Sensors



Retroreflective sensors incorporate emitter and receiver in the same housing. The light beam of the emitter is aimed at a reflector, which reflects the beam back to the receiver. An object is detected if it interrupts the light beam.

The clear object sensors are sensitive enough to detect transparent film, glass bottles and other transparent objects. The coaxial optical design considerably reduces the blind zone of the devices. Even highly reflective objects are reliably detected thanks to the integrated pole filters. The device enables three different limit values to be monitored. This makes it possible to distinguish objects with varying transparency. The devices can readjust themselves in order to reduce impairment through dirt and dust.

## Features

- Compact design
- Coaxial optical design
- Setting via potentiometers
- Transmission of process values and parameterization via IO-Link

## Type Code

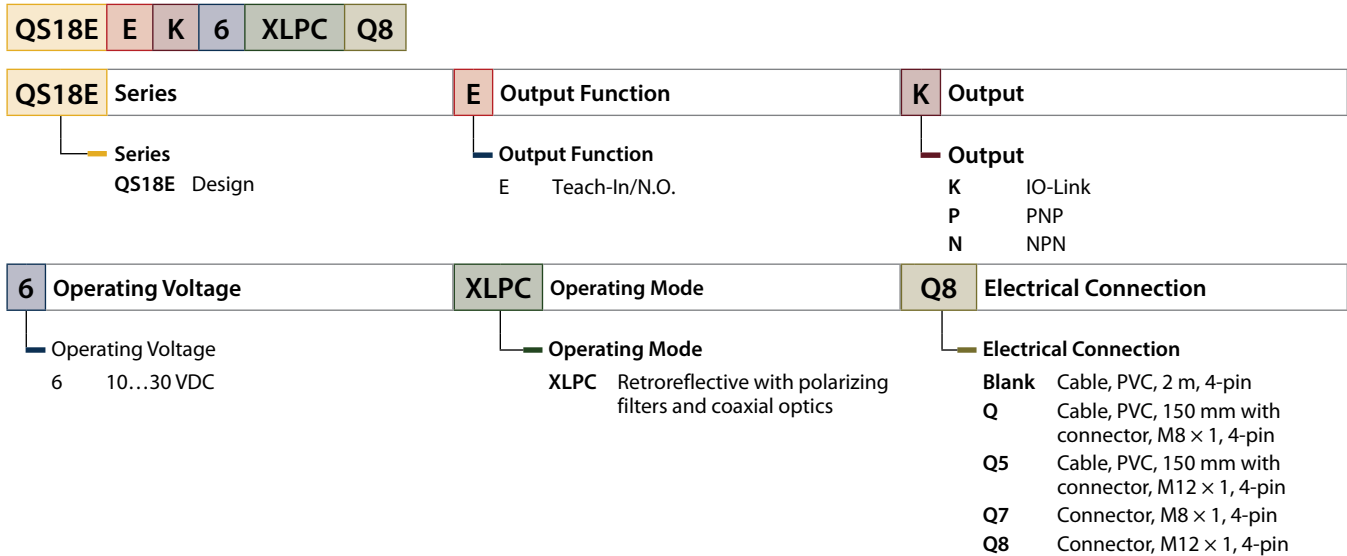



## QS18 Clear Object Sensors



General data			
Communication Mode	COM 2 (38.4 kBaud)	Dimensions	31 x 15 x 35 mm
IO-Link port type	Class A	Light type	Red polarized
IO-Link Specification	V 1.1		

### Types and Data – Selection table

Type	ID number
QS18EK6XLPCQ8	3801273
QS18EK6XLPCQ5	3801743

# Fiber Optic Sensors



Plastic fibers are the optimum choice for high-temperature applications and limited spaces. Optical fibers transfer the light from the sensor to a remote object. Single optical fibers are suited for opposed sensing mode, while bifurcated optical fibers are best suited for diffuse sensing mode. The sensors are set via a pushbutton on the housing. The integrated display facilitates adjustment and displays the selected signal strength.

## Features

- Compact design
- 8-digit 7-segment display
- Setting via pushbutton
- Fast response time
- Transmission of process values and parameterization via IO-Link

## Type Code

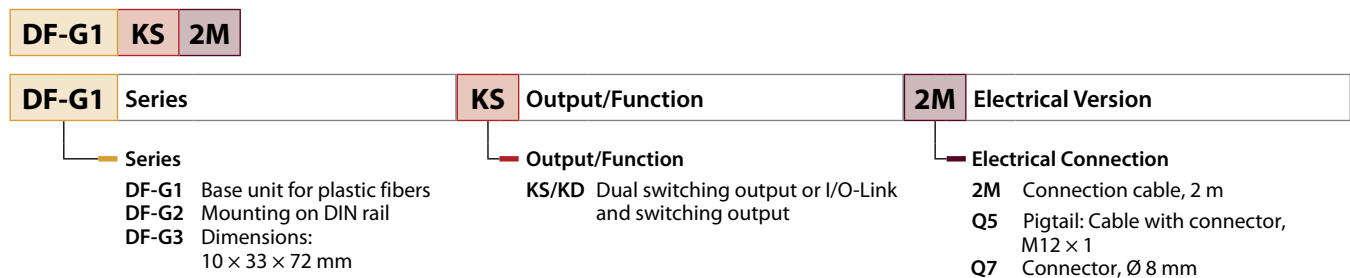

Fiber Optic Sensors DF-G



**General data**

<b>Communication Mode</b>	COM 2 (38.4 kBaud)	<b>Dimensions</b>	79.3 x 10 x 33 mm
<b>IO-Link port type</b>	Class A	<b>Light type</b>	Red
<b>IO-Link Specification</b>	V 1.1		

**Types and Data – Selection table**

<b>Type</b>	<b>ID number</b>
DF-G1-KS-Q7	3025793
DF-G1-KS-Q5	3019524
DF-G1-KS-2M	3025791
DF-G2-KD-Q7	3097703
DF-G2-KD-Q5	3097702
DF-G2-KD-2M	3097700
DF-G3-KD-Q7	3097711
DF-G3-KD-Q5	3097710
DF-G3-KD-2M	3097708

# LED Signal and Indicator Lights



The TL50 LED tower lights indicate statuses clearly visible and permit a clear operator guidance within the entire plant. Each tower light is configured from different colored LED elements with or without a beeper and is installed ready for operation in a few handling steps. The LED elements and their flashing frequency, as well as the beeper can be individually controlled via IO-Link.

The K50L2 LED indicators offer all-round visibility thanks to their RGB LEDs with high luminance and true colors. Over a million different colors as well as flash frequencies or color changes can be set via IO-Link.

## Features

- Individual color combinations
- Colors: Green, Red, Yellow, Blue, White
- Different beepers: continuous, pulse or staccato sound
- High luminance and true colors
- All-round visibility

## Type Code

**TL50** **GYR** **A** **K** **Q**

<b>TL50</b> Series	<b>GYR</b> Color	<b>A</b> Acoustic Alarm
<p>Series</p> <p>TL50 Standard</p>	<p>Color</p> <p>G Green</p> <p>Y Yellow</p> <p>R Red</p> <p>B Blue</p> <p>W White</p>	<p>Acoustic Alarm</p> <p>– Not available (IP67)</p> <p>A Beeper (IP50)</p> <p>AOSI Omnidirectional beeper, continuous tone with adjustable intensity (IP67)</p> <p>AOS3I Omnidirectional beeper, pulsed tone with adjustable intensity (IP67)</p> <p>AOS4I Omnidirectional beeper, staccato tone with adjustable intensity (IP67)</p>
<b>K</b> Operating Mode	<b>Q</b> Connection	
<p>Operating Mode</p> <p>K IO-Link</p>	<p>Connection</p> <p>Q Integrated M12 connector</p>	

**K50L2** **RGB** **K** **ALS** **Q**

<b>K50L2</b> Series	<b>RGB</b> Color	<b>K</b> Input
<p>Series</p> <p>K50L2 Multifunction display (2nd Generation) cylinder, plastic: Ø 50 mm, thread: Ø 30 mm</p>	<p>LED Colors</p> <p>B Blue</p> <p>G Green</p> <p>Y Yellow</p> <p>R Red</p> <p>X No other function</p> <p>2 3 colors/7 functions</p> <p><b>Audible Signals</b></p> <p>Blank Without audible signals</p> <p>A With audible signals</p>	<p>Input</p> <p>P PNP</p> <p>N NPN</p>
<b>ALS</b> Audible Signals	<b>Q</b> Electrical Connection	
<p>Audible Signals</p> <p>Blank Without audible signals</p> <p>A1 Beeper with continuous tone (IP50)</p> <p>AL1 Beeper with loud continuous tone (IP50)</p> <p>ALS Beeper with loud continuous tone (IP67)</p>	<p>Electrical Connection</p> <p>Q M12 × 1 connector</p> <p>QP Pigtail: integrated cable 150 mm, with M12 × 1 connector</p>	

TL50 Tower Light with and without Beeper



**General data**

<b>Communication Mode</b>	COM 2 (38.4 kBaud)	<b>IO-Link Specification</b>	V 1.1
---------------------------	--------------------	------------------------------	-------

**Types and Data – Selection table**

Type	ID number	Dimensions [mm]	Light type
TL50GYRKQ	3801283	50 x 142.6	Green, Yellow, Red
TL50BGYRKQ	3801284	50 x 183.3	Blue, Green, Yellow, Red
TL50WBGYRKQ	3801285	50 x 224	White, Blue, Green, Yellow, Red
TL50GYRAKQ	3801290	50 x 173.4	Green, Yellow, Red
TL50BGYRAKQ	3801291	50 x 214.1	Blue, Green, Yellow, Red
TL50WBGYRAKQ	3801292	50 x 254.8	White, Blue, Green, Yellow, Red

K50L2 Indicator with RGB LEDs



**General data**

<b>Communication Mode</b>	COM 2 (38.4 kBaud)	<b>Light type</b>	RGB
<b>IO-Link Specification</b>	V 1.1		

**Types and Data – Selection table**

Type	ID number	Dimensions [mm]
K50L2RGBKQ	3802158	50 x 37.3
K50L2RGBKQP	3802159	50 x 37.3
K50L2RGBKA1Q	3802160	50 x 56.8
K50L2RGBKALSQ	3802164	50 x 61.8

# Cabinet Guards



The IM12-CCM cabinet guard increases the availability and safety of machines and plants efficiently and inexpensively. The device uses sensors to continuously monitor temperature, humidity and the correct closure of the front door. Any limit value violations are indicated via a switch contact. IO-Link provides users with a detailed view inside the control cabinet. Application-specific configurations, actual measured values as well as historical data over a period of up to 2 years can be read from the device and used, for example, for trend evaluations.

## Features

- Application-specific configuration
- Data logger for trend detection
- Access to all measured values

## Type Code

**IM X D 12 - CCM - 01 - 1S - 1I - H / 24 VDC CC**

**IM X D** Design - **12** Housing Width - **CCM** Device Functions -

IM	X	D	Special Functions			12	Housing Width			CCM	Device Functions		
			D	Display			12	12 mm			CCM	Cabinet guard	
			K	Compact design			18	18 mm					
			Application Area										
			X	Ex area									
			Blank	Non-Ex area									
			Design										
			IM	Interface module									

**01** Version - **1S** Input Function - **1I** Output Function -

01	Version		1S	Input Function			1I	Output Function		
	01	External and internal sensors, humidity, temperature, infrared, reed contact, infrared 12C		1	S	Switch		1	I	Current
	02	Only internal sensors, humidity, temperature, infrared, infrared 12C		2	NAM	Namur		2	U	Voltage
	03	CAN-bus, external and internal sensors, humidity, temperature, infrared, reed contact, infrared 12C		3	F	Frequency		3	T	Potential-free transistor
	04	Ex-version with pulse output as quasi analog output, external and internal sensors, humidity, temperature, infrared, reed contact, infrared 12C		4	I	Current		4	PNP	Transistor, PNP
			5	U	Voltage	5	NPN	Transistor, NPN		
			6	TC	Thermocouple		MT	MOSFET		
			7	RTD	Temperature-dependent resistor		R	Relay		
			8	POT	Potentiometer		RTD	Resistor		
			9	R	Resistor		NAM	NAMUR		
			10	MTIS	Humidity		F	Frequency		
			11		Temperature		PP	Push-Pull (level)		
			12		Infrared					
			13		Switch					

**H** Special Functions / **24 VDC** Power Supply **CC** Electrical Connection

H	Special Functions		24 VDC	Power Supply		CC	Electrical Connection		
	H	HART®		24 VDC	10...30 VDC		CC	Cage clamp terminals	
	C	Computer parameterizable		24 VUC	10...30 VUC		Blank	Screw terminals	
	PR	Power Bridge		L	Loop-powered				
	S	Fault alarm output		W1	20 ... 250 VAC				
	P	Pulse			20...125 VDC				
	0	No		W2	20 ... 250 VAC				
IOL	IO-Link		20...250 VDC						

## Cabinet Guards



### General data

<b>Protection class</b>	IP20	<b>Ambient temperature</b>	-25...+70 °C
-------------------------	------	----------------------------	--------------

### Types and Data – Selection table

Type	ID number	Electrical connection	Description	Dimensions [mm]
IM12-CCM03-MTIS-3T-IOLC-PR/24V	7570102	Removable screw clamp terminals, 2-pin	Cabinet guard; Non-Ex type; IO-Link interface for parameter setting; removable screw terminals; Power Bridge	120 x 12.5 x 117
IM12-CCM03-MTIS-3T-IOLC-PR/24V/CC	7570103	Removable cage clamp terminals, 2-pin	Cabinet guard; Non-Ex type; IO-Link interface for parameter setting; removable cage clamp terminals; Power Bridge	120 x 12.5 x 128
IM12-CCM03-MTIS-3T-IOLC/24V	7570100	Removable screw clamp terminals, 2-pin	Cabinet guard; Non-Ex type; IO-Link interface for parameter setting; removable screw terminals	120 x 12.5 x 117
IM12-CCM03-MTIS-3T-IOLC/24V/CC	7570101	Removable cage clamp terminals, 2-pin	Cabinet guard; Non-Ex type; IO-Link interface for parameter setting; removable cage clamp terminals	120 x 12.5 x 128

# I/O Hubs



For an intelligent signal distribution of digital I/Os, Turck's I/O hubs can be a cost-effective and low maintenance solution. The devices reduce the wiring effort considerably and offer outstanding performance with the known functions of a conventional passive distributor. Moreover, the hubs provide additional functions that can prepare the device ideally for applications. These include an application-specific marker and adjustable inputs and outputs.

## Features

- Reduced installation work
- Inexpensive replacement of passive junctions
- Intelligent signal integration of simple sensors and actuators

## Type Code

**TB IL - M1 - 16 DXP**

<b>TB</b>	<b>IL</b>	<b>Bus System/Interface</b>	-	<b>M1</b>	<b>Design/Connection</b>	-	<b>16</b>	<b>DXP</b>	<b>Signal Type</b>
		<ul style="list-style-type: none"> <li>Bus System/Interface</li> <li>IL IO-Link interface</li> </ul>			<ul style="list-style-type: none"> <li>Design/Connection</li> <li>S2 Short version, 4 x M12 I/O</li> <li>L1 Long version, 8 x M12 I/O</li> <li>M1 Medium-long version, 8 x M12 I/O</li> </ul>				<ul style="list-style-type: none"> <li>Signal Type</li> <li>DIP Digital inputs, 2 signals per port</li> <li>DOP Digital outputs, 1 signal per port</li> <li>DXP Universal digital I/Os</li> </ul>
		<ul style="list-style-type: none"> <li>Product Series</li> <li>TB Compact block I/O module</li> </ul>							<ul style="list-style-type: none"> <li>Number of Channels</li> <li>8 8 channels</li> <li>16 16 channels</li> </ul>



I/O Hubs

**General data**

<b>IO-Link Specification</b>	Specified acc. to version 1.1	<b>Dimensions</b>	150 x 54 x 27.4 mm
------------------------------	-------------------------------	-------------------	--------------------



**Types and Data – Selection table**

Type	ID number
TBIL-M1-16DIP	6814100
TBIL-M1-8DOP	6814101
TBIL-M1-16DXP	6814102

# NIC Coupler System



The inductive couplers of the NIC series are designed for contactless bidirectional transmission of power and data. The coupler sets consist of two components, the primary part NICP on the control side and the secondary part NICS at the sensor/ actuator side. The primary part supplies the secondary part with power via the air interface. In return the secondary part provides data to the connected sensors and actuators. The full IO-Link support makes the NIC system particularly flexible. The solution is therefore suited on the one hand for the bidirectional data transmission from and to the IO-Link devices, but also for the transmission of 8 PNP signals via a 12-wire cable, which is handled internally via IO-Link.

## Features

- Contactless transmission of up to 8 PNP switching signals and up to 500 mA currents with 12 watts of power
- Transmission distance (air interface) to 7 mm at full power
- Full IO-Link support

## Type Code

**NIC P - M30 - IOL 2P8X H1141**

<b>NIC</b>	<b>Functional Principle</b>	<b>P</b>	<b>Component</b>	-	<b>M30</b>	<b>Design</b>	-
	<b>Functional Principle</b> NIC Non-flush inductive coupler		<b>Component</b> P Primary side (Emitter) S Secondary side (Receiver)			<b>Design</b> M30 M30 × 1.5 threaded barrel	

<b>IOL</b>	<b>Technology</b>	<b>2</b>	<b>P</b>	<b>8</b>	<b>X</b>	<b>Electrical Version</b>	-	<b>H1141</b>	<b>Electrical Connection</b>
	<b>Technology</b> IOL IO-Link					<b>Indication</b> X LED  <b>Voltage Range</b> 8 24VDC, short-circuit proof  <b>Output Mode</b> P PNP  <b>Number of Channels</b> 2 2 channels 8 8 channels			<b>Electrical Connection</b> H1141 Integrated connector, M12 × 1, 4-pin  0.3-RKC4.4T Pigtail: 0.3 m cable with female connector, M12 × 1, 4-pin  0.3-RSC12T Pigtail: 0.3 m cable with male connector, M12 × 1, 12-pin

## Inductive Couplers



### General data

<b>Mounting conditions</b>	Non-flush	<b>Housing designation</b>	M30 × 1.5
<b>Description</b>	Cylindrical, threaded barrel, 30 mm, chrome-plated brass	<b>Protection class</b>	IP67 IP68
<b>Operating voltage</b>	24 VDC	<b>Housing material</b>	CuZn
<b>Quality active face</b>	PA	<b>Ambient temperature</b>	-20...+55 °C

### Types and Data – Selection table

Type	ID number	Electrical connection	Operating current	Output function	Dimensions [mm]
NICP-M30-IOL2P8X-H1141	4300101	Connector, M12 × 1	750 DC	PNP & IO-Link	30 x 77.1
NICP-M30-8P8-0.3-RSC12T	4300201	0.3 m, Cable with male connector, M12 × 1	750 DC	PNP	30 x 80.4
NICS-M30-IOL2P8-0.3-RKC4.4T	4300301	0.3 m, Cable with female connector, M12 × 1	500 DC	PNP & IO-Link	30 x 80.4

# PUR Cable – Green, Type 4414

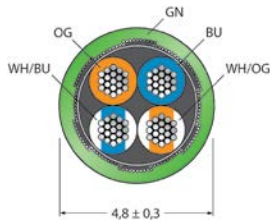

- 4-pin, 4 × 24 AWG, CAT 5E
- Qualified for drag chain use and flame-retardant
- Resistant to UV radiation and oils
- Free from halogen, silicone, PVC and LABS
- cULus approved



## Female connector



- 1 = WH/OG (TX +)
- 2 = OG (TX -)
- 3 = WH/BU (RX +)
- 4 = n.c.
- 5 = n.c.
- 6 = BU (RX -)
- 7 = n.c.
- 8 = n.c.

## Male connector



Connector	
Protection class	IP67 (A + B side screwed together)
Mechanical lifespan	> 100 Mating cycles
Pollution degree	3/2
Cable	
Core insulation	PP (WHOG, WHBU, BU, OG)
Shielding	Aluminum foil, tinned copper wire
Electrical properties at +20 °C	
Current	3 A
Test voltage	700 V
Nom. impedance	100 (1MHZ)
Nom. capacitance	51 pF/m
Mechanical and chemical properties	
Bending cycles	> 5 mil.
Bending radius (stationary laying)	> 15 x Ø



	Number of pins	Cable length [m]	Rated voltage [V]	ID number	Type
	4	1	30	6932993	PSGS4M-PSGS4M-4414-1M
	4	2	30	6932994	PSGS4M-PSGS4M-4414-2M
	4	5	30	6932996	PSGS4M-PSGS4M-4414-5M
	4	10	30	6932999	PSGS4M-PSGS4M-4414-10M
	4	15	30	6933000	PSGS4M-PSGS4M-4414-15M
	4	1	48	6441404	RSSD-RSSD-4414-1M
	4	2	48	6441405	RSSD-RSSD-4414-2M
	4	5	48	6441406	RSSD-RSSD-4414-5M
	4	10	48	6441408	RSSD-RSSD-4414-10M
	4	15	48	6441409	RSSD-RSSD-4414-15M
	4	1	30	6933772	RSSD-PSGS4M-4414-1M
	4	2	30	6933008	RSSD-PSGS4M-4414-2M
	4	5	30	6933009	RSSD-PSGS4M-4414-5M
	4	10	30	6933010	RSSD-PSGS4M-4414-10M
	4	15	30	6935277	RSSD-PSGS4M-4414-15M
	4	1	48	6933004	PSGS4M-RJ45S-4414-1M
	4	2	48	6933005	PSGS4M-RJ45S-4414-2M
	4	5	48	6933768	PSGS4M-RJ45S-4414-5M
	4	10	48	6934252	PSGS4M-RJ45S-4414-10M
	4	15	48	6933308	PSGS4M-RJ45S-4414-15M
	4	1	48	6441412	RSSD-RJ45S-4414-1M
	4	2	48	6441413	RSSD-RJ45S-4414-2M
	4	5	48	6935267	RSSD-RJ45S-4414-5M
	4	10	48	6441415	RSSD-RJ45S-4414-10M
	4	15	48	6441416	RSSD-RJ45S-4414-15M

## PUR Cable – black

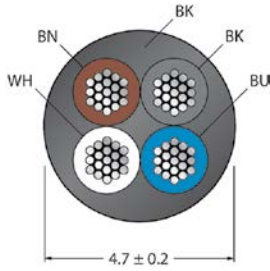

- PUR sheath (type...TXL)
- Qualified for drag chain use
- Resistant to welding sparks
- Resistant to chemicals, UV radiation and oils
- Flame-retardant
- No halogen, silicone, PVC or paint-wetting substances (LABS)
- cULus approval
- RoHS-compliant
- Other cable lengths and colors on request



### Female connector

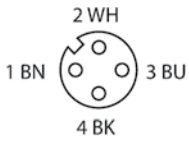

### Male connector

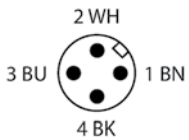

### Connector

Protection class	IP67 (A + B side screwed together)
Mechanical lifespan	> 100 Mating cycles
Pollution degree	3

### Cable

Core insulation	PP (BN, WH, BU, BK)
-----------------	---------------------

### Electrical properties at +20 °C

Current	4 A
Rated voltage	250 V
Insulation resistance	> 30.5 MΩ/km
Test voltage	2000 V
Forward resistance	max. 57 Ω/km

### Mechanical and chemical properties

Bending cycles	> 5 mil.
Bending radius (stationary laying)	> 5 × Ø
Bending radius (flexible use)	> 10 × Ø
Admissible acceleration	max. 5 m/s <sup>2</sup>
Admissible travel path, horizontal	5 m (at 5 m/s <sup>2</sup> )
Admissible travel path, vertical	2 m (at 5 m/s <sup>2</sup> )
Admissible traversing speed	3.3 m/s
Torsional stress	± 180 °/m



	Number of pins	Cable length [m]	Rated voltage [V]	ID number	Type
	4	0.3	250	6625605	RKC4.4T-0.3-RSC4.4T/TXL
	4	0.6	250	6625606	RKC4.4T-0.6-RSC4.4T/TXL
	4	1	250	6625607	RKC4.4T-1-RSC4.4T/TXL
	4	2	250	6625608	RKC4.4T-2-RSC4.4T/TXL
	4	5	250	6625731	RKC4.4T-5-RSC4.4T/TXL
	4	0.3	250	6625637	WKC4.4T-0.3-RSC4.4T/TXL
	4	0.6	250	6625638	WKC4.4T-0.6-RSC4.4T/TXL
	4	1	250	6625639	WKC4.4T-1-RSC4.4T/TXL
	4	2	250	6625640	WKC4.4T-2-RSC4.4T/TXL
	4	5	250	6626878	WKC4.4T-5-RSC4.4T/TXL
	4	0.3	250	6625621	RKC4.4T-0.3-WSC4.4T/TXL
	4	0.6	250	6625622	RKC4.4T-0.6-WSC4.4T/TXL
	4	1	250	6625623	RKC4.4T-1-WSC4.4T/TXL
	4	2	250	6625624	RKC4.4T-2-WSC4.4T/TXL
	4	5	250	6626682	RKC4.4T-5-WSC4.4T/TXL
	4	0.3	250	6625653	WKC4.4T-0.3-WSC4.4T/TXL
	4	0.6	250	6625654	WKC4.4T-0.6-WSC4.4T/TXL
	4	1	250	6625655	WKC4.4T-1-WSC4.4T/TXL
	4	2	250	6625656	WKC4.4T-2-WSC4.4T/TXL
	4	5	250	6626684	WKC4.4T-5-WSC4.4T/TXL

# IO-Link Master



Turck IO-Link masters are available in both modular and compact block I/O design. With IO-Link 1.1 they cover all required modes of communication. This allows the user to easily integrate the wide range of Turck IO-Link devices in various fieldbus systems. Thanks to the multiprotocol Ethernet technology, the masters ensure efficient operation, also in new installations controlled by an Ethernet-enabled PLC system. With the IP20 and IP67 variants, solutions for use in control cabinets as well as for direct installation in the field are provided.

## Features

- Application-optimized I/O systems in IP20 and IP67
- Space-saving block I/Os with multiple configuration options
- Future-proof module through IO-Link 1.1

## Type Code

**TB EN - S2 - 4IOL**

<b>TB</b>	<b>EN</b>	Bus System	-	<b>S2</b>	Design/Connection	-	<b>4IOL</b>	Signal Type
		<b>Bus System</b> EN Ethernet multiprotocol PN Profisafe IP Ethernet/IP™CIP-Safety  <b>Product Series</b> TB Compact block I/O module		<b>Design/Connection</b> S2 Small - I/O connection: 4 x M12 female connector; Power: M8 male/female connector, 4-pin L1 Large - I/O connection: 8 x M12 female connector; Power: 7/8"male/female,5-pin L4 Large - I/O connection: 8 x M12 female connector; Power: 7/8"male/female,4-pin L5 Large - I/O connection: 8 x M12 female connector; Power: 7/8"male/female,5-pin			<b>Signal Type</b> 4IOL 4 IO-Link master ports 8IOL 8 IO-Link master ports FDIO1 Safety I/O Set1 2 digital SIL3 inputs FDI 2 digital SIL3 channels as FDI or FDO (PP, PM)	

**BL20 - E - 4IOL**

<b>BL20</b>	Product Series	-	<b>E</b>	Design	-	<b>4IOL</b>	Signal Type
<b>Product Series</b> BL20 Modular I/O system in IP20			<b>Design</b> E ECO design			<b>Signal Type</b> 2IOL 2 IO-Link master ports 4IOL 4 IO-Link master ports	

**BL67 - 4IOL**

<b>BL67</b>	Product Series	-	<b>4IOL</b>	Signal Type
<b>Product Series</b> BL67 Modular I/O system in IP67			<b>Signal Type</b> 4IOL 4 IO-Link master ports	





## Block I/O Module



### General data

IO-Link specification      Version 1.1

### Types and Data – Selection table

Type	ID number	IO-Link port type	Number of channels	Dimensions [mm]
TBEN-L4-8IOL	6814082	Class A and Class B	8	230.4 x 60.4 x 39
TBEN-L5-8IOL	6814017	Class A and Class B	8	230.4 x 60.4 x 39
TBPN-L1-FDIO1-2IOL	6814053	Class A and Class B	2	230.4 x 60.4 x 39
TBEN-S2-4IOL	6814024	Class A	4	144 x 32 x 32
TBIP-L5-FDIO1-2IOL	6814056	Class A and Class B	2	230.4 x 60.4 x 39

## Modular System



### General data

IO-Link port type      Class A      Number of channels      4  
 IO-Link specification      version 1.1

### Types and Data – Selection table

Type	ID number	Dimensions [mm]
BL67-4IOL	6827386	91 x 32 x 59
BL20-E-4IOL	6827385	128.6 x 12.6 x 74.6

# Turck Worldwide

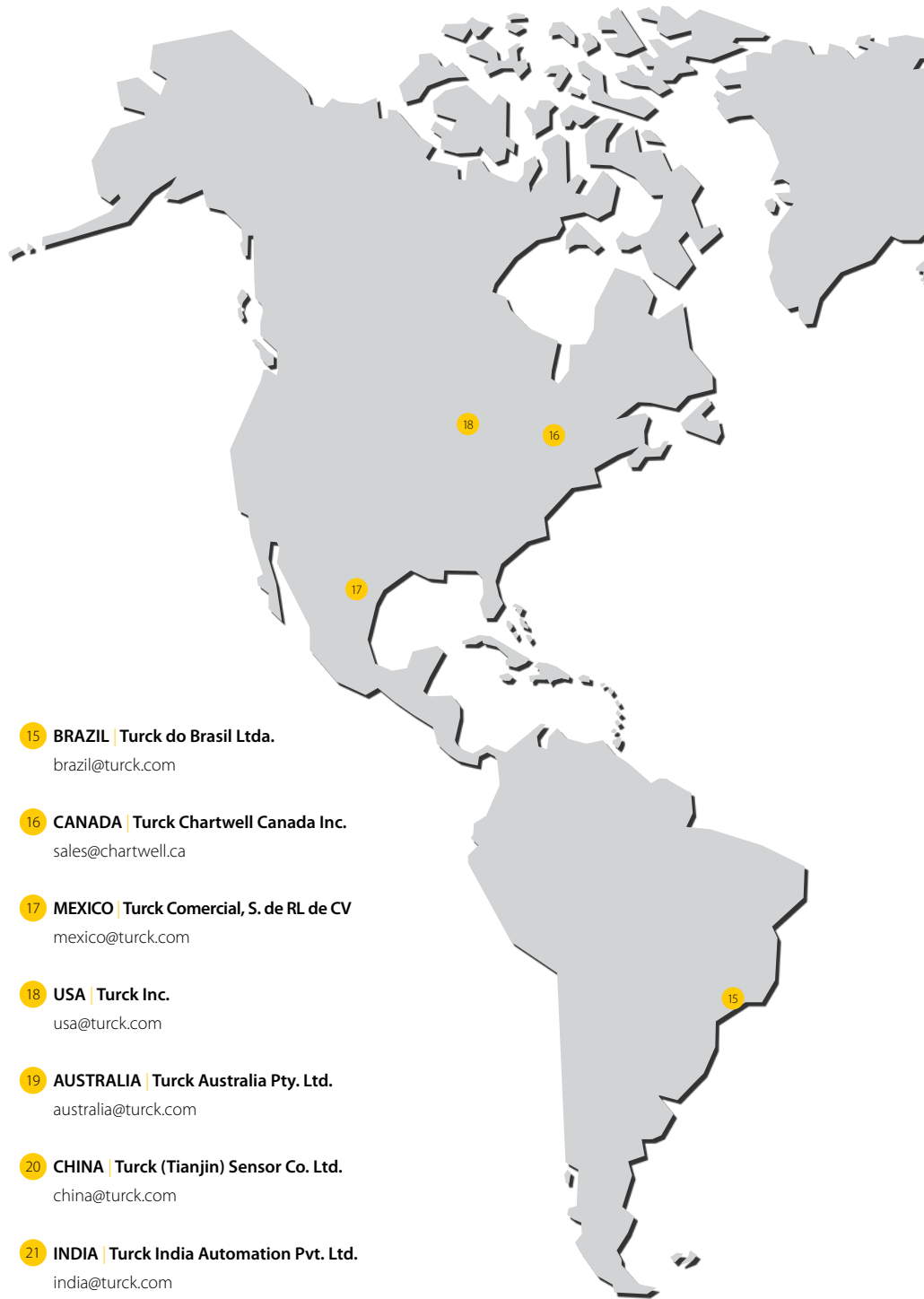

**1 GERMANY | Corporate Headquarters**  
**Hans Turck GmbH & Co. KG**  
Witzlebenstraße 7, Mülheim an der Ruhr  
T +49 208 4952-0, [more@turck.com](mailto:more@turck.com)

**2 BELGIUM | Turck Multiprox N. V.**  
[mail@multiprox.be](mailto:mail@multiprox.be)

**3 FRANCE | Turck Banner S. A. S.**  
[info@turckbanner.fr](mailto:info@turckbanner.fr)

**4 UNITED KINGDOM | Turck Banner LIMITED**  
[enquiries@turckbanner.com](mailto:enquiries@turckbanner.com)

**5 ITALY | Turck Banner S. r. l.**  
[info@turckbanner.it](mailto:info@turckbanner.it)

**6 NETHERLANDS | Turck B. V.**  
[netherlands@turck.com](mailto:netherlands@turck.com)

**7 AUSTRIA | Turck GmbH**  
[austria@turck.com](mailto:austria@turck.com)

**8 POLAND | Turck sp.z o.o.**  
[poland@turck.com](mailto:poland@turck.com)

**9 ROMANIA | Turck Automation România SRL**  
[romania@turck.com](mailto:romania@turck.com)

**10 RUSSIA | O.O.O. Turck Rus**  
[russia@turck.com](mailto:russia@turck.com)

**11 SWITZERLAND | Bachofen AG**  
[info@bachofen.ch](mailto:info@bachofen.ch)

**12 CZECH REPUBLIC | Turck s. r. o.**  
[czech@turck.com](mailto:czech@turck.com)

**13 TURKEY | Turck Otomasyon Tic. Ltd. Şti.**  
[turkey@turck.com](mailto:turkey@turck.com)

**14 HUNGARY | Turck Hungary Kft.**  
[hungary@turck.com](mailto:hungary@turck.com)

**15 BRAZIL | Turck do Brasil Ltda.**  
[brazil@turck.com](mailto:brazil@turck.com)

**16 CANADA | Turck Chartwell Canada Inc.**  
[sales@chartwell.ca](mailto:sales@chartwell.ca)

**17 MEXICO | Turck Comercial, S. de RL de CV**  
[mexico@turck.com](mailto:mexico@turck.com)

**18 USA | Turck Inc.**  
[usa@turck.com](mailto:usa@turck.com)

**19 AUSTRALIA | Turck Australia Pty. Ltd.**  
[australia@turck.com](mailto:australia@turck.com)

**20 CHINA | Turck (Tianjin) Sensor Co. Ltd.**  
[china@turck.com](mailto:china@turck.com)

**21 INDIA | Turck India Automation Pvt. Ltd.**  
[india@turck.com](mailto:india@turck.com)

**22 JAPAN | Turck Japan Office**  
[japan@turck.com](mailto:japan@turck.com)

**23 KOREA | Turck Korea Co. Ltd.**  
[korea@turck.com](mailto:korea@turck.com)

**24 SINGAPORE | Turck Singapore Pte. Ltd.**  
[singapore@turck.com](mailto:singapore@turck.com)



# TURCK

28 subsidiaries and over  
60 representations worldwide!

D900637 | 2017/11



[www.turck.com](http://www.turck.com)