

Q4X Stainless Steel Laser Sensor with Dual Discrete Outputs and IO-Link

Instruction Manual

Original Instructions
190074 Rev. D
17 January 2017
© Banner Engineering Corp. All rights reserved



190074

Contents

1 Product Description	3
1.1 Models	3
1.2 Overview	3
1.3 Features	4
1.3.1 Display and Indicators	4
1.3.2 Buttons	4
1.4 Laser Description and Safety Information	5
2 Installation	6
2.1 Install the Safety Label	6
2.2 Sensor Orientation	6
2.3 Mount the Sensor	6
2.4 Wiring Diagram	7
2.5 Cleaning and Maintenance	7
3 Sensor Programming	8
3.1 Channel 1 and Channel 2 (CH1/CH2)	8
3.2 Setup Mode	8
3.2.1 Output	10
3.2.2 TEACH Mode	11
3.2.3 Adaptive Tracking	11
3.2.4 Window Size	11
3.2.5 Response Speed —100/110/300/310 mm Models	12
3.2.6 Response Speed —600/610 mm Models	12
3.2.7 Gain and Sensitivity	12
3.2.8 Output Timing Delays	13
3.2.9 Zero Reference Location	14
3.2.10 Shift the Zero Reference Location after a TEACH	14
3.2.11 Offset	15
3.2.12 Display View	16
3.2.13 Exit Setup Mode	16
3.2.14 Reset to Factory Defaults	16
3.3 Manual Adjustments	16
3.4 Remote Input	17
3.4.1 Select the TEACH Mode Using the Remote Input	17
3.4.2 Reset to Factory Defaults Using the Remote Input	18
3.5 Locking and Unlocking the Sensor Buttons	18
3.6 TEACH Procedures	19
3.6.1 Two-Point Static Background Suppression	19
3.6.2 Dynamic Background Suppression	21
3.6.3 One-Point Window (Foreground Suppression)	22
3.6.4 One-Point Background Suppression	25
3.6.5 Dual (Intensity + Distance)	27
3.7 Pulse Frequency Modulation (PFM) Output	28
3.8 Sync Master/Slave	28
4 IO-Link Interface	29
5 Specifications	30
5.1 Dimensions	32
5.2 Performance Curves—Threaded Barrel Models	34
5.3 Performance Curves—Flush Mount Models	35
6 Additional Information	36
6.1 Dual (Intensity + Distance) Mode	36
6.2 Dual Mode Reference Surface Considerations	36
6.3 Dual Mode Considerations for Clear and Transparent Object Detection	36
6.4 Abbreviations	38
7 Troubleshooting	40
8 Accessories	41
8.1 Cordsets	41
8.2 Brackets	43
8.3 Aperture Kits—Threaded Barrel Models	44
8.4 Reference Targets	44
9 Contact Us	45
10 Banner Engineering Corp. Limited Warranty	46

1 Product Description

Class 1 laser CMOS sensor with dual outputs and IO-Link. Patent pending.

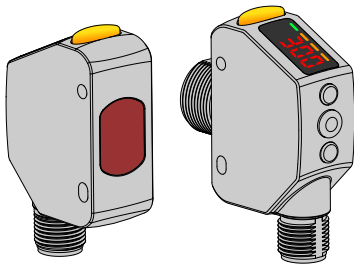

Figure 1. Flush Mount (Left) and Threaded Barrel (Right) Models

- The ultimate problem solver: reduce sensor inventory with a reliable, durable sensor that solves the most challenging applications
- Solves difficult distance-based applications regardless of target surface reflectivity, including black foam on black plastic, black rubber in front of metal, transparent objects, multicolor packaging, and targets of all colors
- Robust housing rated to IP69K with FDA-grade stainless steel resists mechanical impact, over tightening and extreme vibration
- Bright output indicator and real time distance feedback provide easy setup and troubleshooting for reduced installation costs
- Dual channels and IO-Link

For illustration purposes, the threaded barrel model Q4X images are used throughout this document.



WARNING: Not To Be Used for Personnel Protection

Never use this device as a sensing device for personnel protection. Doing so could lead to serious injury or death. This device does not include the self-checking redundant circuitry necessary to allow its use in personnel safety applications. A sensor failure or malfunction can cause either an energized or de-energized sensor output condition.

1.1 Models

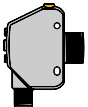
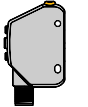
Model	Sensing Range	Channel 1	Channel 2	Connection
	Q4XTKLAF600-Q8 25 mm to 600 mm (0.98 in to 23.62 in)	IO-Link, Push/pull output	PNP only output or input, or pulse frequency modulated output	Integral 4-pin M12/ Euro-style male quick disconnect (QD)
	Q4XTKLAF300-Q8 25 mm to 300 mm (0.98 in to 11.81 in)			
	Q4XTKLAF100-Q8 25 mm to 100 mm (0.98 in to 3.94 in)			
	Q4XFKLAF610-Q8 35 mm to 610 mm (1.38 in to 24.02 in)	IO-Link, Push/pull output	PNP only output or input, or pulse frequency modulated output	Integral 4-pin M12/ Euro-style male quick disconnect (QD)
	Q4XFKLAF310-Q8 35 mm to 310 mm (1.38 in to 12.20 in)			
	Q4XFKLAF110-Q8 35 mm to 110 mm (1.38 in to 4.33 in)			

1.2 Overview

The Q4X sensor with dual discrete outputs and IO-Link is a Class 1 laser CMOS sensor with an IO-Link and multifunction output. The normal sensor state is Run mode. From Run mode, the switch point value and channel selection can be changed and the selected TEACH method can be performed. The secondary sensor state is Setup mode. From Setup mode, the TEACH mode can be selected, all standard operating parameters can be adjusted, and a factory reset can be done.

1.3 Features

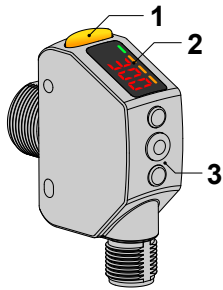

Figure 2. Sensor Features

1. Output Indicator (Amber)
2. Display
3. Buttons

1.3.1 Display and Indicators

The display is a 4-digit, 7-segment LED. The main screen is the Run mode screen.

For 2-pt, BGS, FGS, and DYN TEACH modes, the display shows the current distance to the target in millimeters. For dual TEACH mode, the display shows the percentage matched to the taught reference surface. A display value of **9999** indicates the sensor has not been taught.



Figure 3. Display in Run Mode

1. Stability Indicator (STB—Green)
2. Active TEACH Indicators
 - DYN—Dynamic (Amber)
 - FGS—Foreground Suppression (Amber)
 - BGS—Background Suppression (Amber)



Note: The indicators represent the currently selected channel. However, if Output 2 is set to something other than LO, DO, or Complementary, then the indicators represent the Channel 1 status.

Output Indicator

- On—Output is on
- Off—Output is off

Active TEACH Indicators (DYN, FGS, and BGS)

- DYN, FGS, and BGS all off—Two-point TEACH mode selected (default)
- DYN on—Dynamic TEACH mode selected
- FGS on—Foreground suppression TEACH mode selected
- BGS on—Background suppression TEACH mode selected
- DYN, FGS, and BGS all on—Dual TEACH mode selected

Stability Indicator (STB)

- On—Stable signal within the specified sensing range
- Flashing—Marginal signal, the target is outside the limits of the specified sensing range, or a multiple peak condition exists
- Off—No target detected within the specified sensing range

1.3.2 Buttons

Use the sensor buttons (SELECT)(TEACH), (+)(CH1/CH2), and (-)(MODE) to program the sensor.

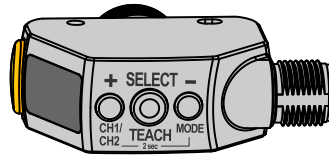

(SELECT)(TEACH)

- Press to select menu items in Setup mode
- Press and hold for longer than 2 seconds to start the currently selected TEACH mode (the default is two-point TEACH)

(+)(CH1/CH2)

- Press to navigate the sensor menu in Setup mode
- Press to change setting values; press and hold to increase numeric values
- Press and hold for longer than 2 seconds to switch between Channel 1 and Channel 2

(-)(MODE)

- Press to navigate the sensor menu in Setup mode
- Press to change setting values; press and hold to decrease numeric values
- Press and hold for longer than 2 seconds to enter Setup mode



Note: When navigating the menu, the menu items loop.

1.4 Laser Description and Safety Information



CAUTION: Use of controls or adjustments or performance of procedures other than those specified herein may result in hazardous radiation exposure. Do not attempt to disassemble this sensor for repair. A defective unit must be returned to the manufacturer.

Class 1 Lasers

Class 1 lasers are lasers that are safe under reasonably foreseeable conditions of operation, including the use of optical instruments for intrabeam viewing.

COMPLIES WITH 21 CFR 1040.10 AND 1040.11 EXCEPT FOR DEVIATIONS PURSUANT TO LASER NOTICE No. 50, DATED JUNE 24, 2007. BANNER ENGINEERING CORP. 9714 10TH AVENUE NORTH MINNEAPOLIS, MN 55441	<div style="border: 2px solid black; padding: 5px; display: inline-block;"> CLASS 1 LASER PRODUCT </div>	COMPLIES WITH IEC 60825-1:2007
---------------------------------------------------------------------------------------------------------------------------------------------------------------------------------------------------------------	-----------------------------------------------------------------------------------------------------------------------------------------------------------------------	--------------------------------

Laser wavelength: 655 nm

Output: < 0.20 mW

Pulse Duration: 7 μ s to 2 ms

2 Installation

2.1 Install the Safety Label

The safety label must be installed on Q4X sensors that are used in the United States.



Note: Position the label on the cable in a location that has minimal chemical exposure.

1. Remove the protective cover from the adhesive on the label.
2. Wrap the label around the Q4X cable, as shown.
3. Press the two halves of the label together.

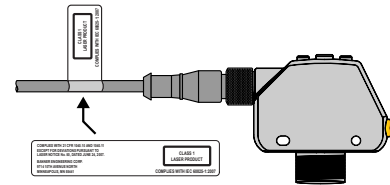

Figure 4. Safety Label Installation

2.2 Sensor Orientation

Optimize detection reliability and minimum object separation performance with correct sensor-to-target orientation. To ensure reliable detection, orient the sensor as shown in relation to the target to be detected.

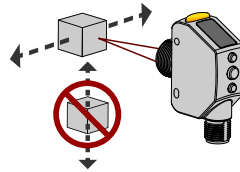

Figure 5. Optimal Orientation of Target to Sensor

See the following figures for examples of correct and incorrect sensor-to-target orientation as certain placements may pose problems for sensing some targets. The Q4X can be used in the less preferred orientation and provide reliable detection performance; refer to the *Performance Curves* for the minimum object separation distance required for each case.

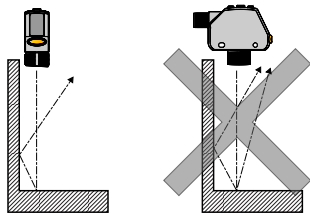

Figure 6. Orientation by a wall

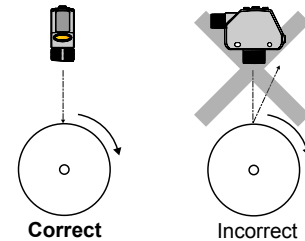

Figure 7. Orientation for a turning object

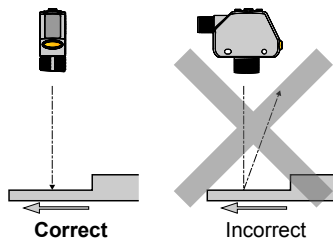

Figure 8. Orientation for a height difference

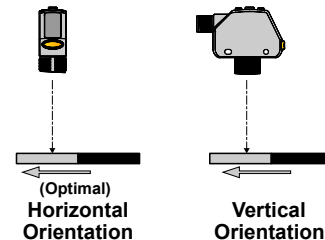

Figure 9. Orientation for a color or luster difference

2.3 Mount the Sensor

1. If a bracket is needed, mount the sensor onto the bracket.
2. Mount the sensor (or the sensor and the bracket) to the machine or equipment at the desired location. Do not tighten the mounting screws at this time.

3. Check the sensor alignment.
4. Tighten the mounting screws to secure the sensor (or the sensor and the bracket) in the aligned position.

2.4 Wiring Diagram

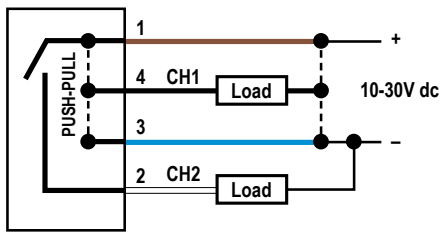

Figure 10. Channel 2 as PNP discrete or PFM output

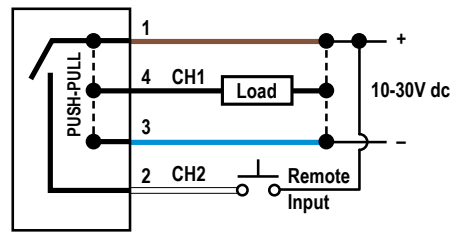
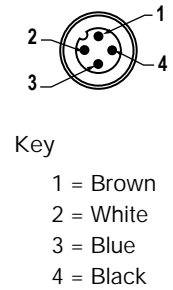

Figure 11. Channel 2 as remote input



Note: Open lead wires must be connected to a terminal block.



Note: The Channel 2 wire function is user-selectable. The default for the wire is PNP output. See the Instruction Manual for details regarding use as remote input or PFM output.

2.5 Cleaning and Maintenance

Handle the sensor with care during installation and operation. Sensor windows soiled by fingerprints, dust, water, oil, etc. may create stray light that may degrade the peak performance of the sensor. Blow the window clear using filtered, compressed air, then clean as necessary using water and a lint-free cloth.

3 Sensor Programming

Program the sensor using the buttons on the sensor or the remote input (limited programming options).

In addition to programming the sensor, use the remote input to disable the buttons for security, preventing unauthorized or accidental programming changes. See [Locking and Unlocking the Sensor Buttons](#) on page 18 for more information.

3.1 Channel 1 and Channel 2 (CH1/CH2)

Press CH1/CH2 button to switch between Channel 1 and Channel 2. Within each channel there are options specific to that channel. For settings that are common to both channels, the menus are only available in Channel 1. The default is Channel 1.





To switch between Channel 1 and Channel 2:

1. Press and hold CH1/CH2 for longer than 2 seconds. The current selection displays.
2. Press CH1/CH2 again. The new selection flashes slowly.
3. Press SELECT to change the Channel and return to Run mode.



Note: If neither SELECT nor CH1/CH2 are pressed after step 2, the new selection flashes slowly for a few seconds, then flashes quickly and the sensor automatically changes the Channel and returns to Run mode.

3.2 Setup Mode

Access Setup mode and the sensor menu from Run mode by pressing and holding MODE for longer than 2 seconds. Use  and  to navigate through the menu. Press SELECT to select a menu option and access the submenus. Use  and  to navigate through the submenus. Press SELECT to select a submenu option and return to the top menu, or press and hold SELECT for longer than 2 seconds to select a submenu option and return immediately to Run mode.

To exit Setup mode and return to Run mode, navigate to **End** and press SELECT.



Note: The number that follows a menu option, for example **ech 1**, indicates the channel that is selected. For menu items without a number (excluding submenu items), these menu options are only available from Channel 1 and the settings apply to both channels.

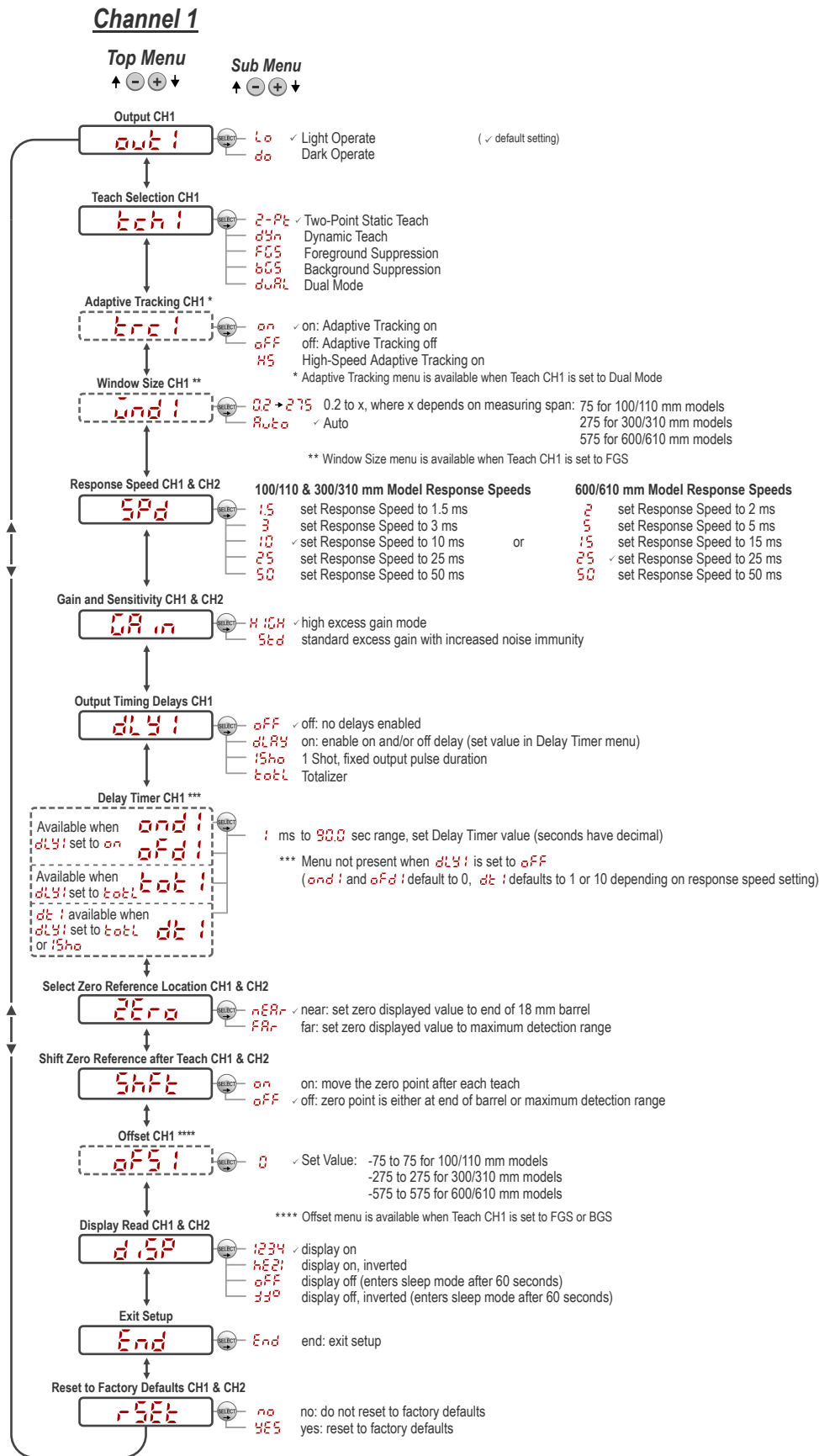

Figure 12. Sensor Menu Map—Channel 1

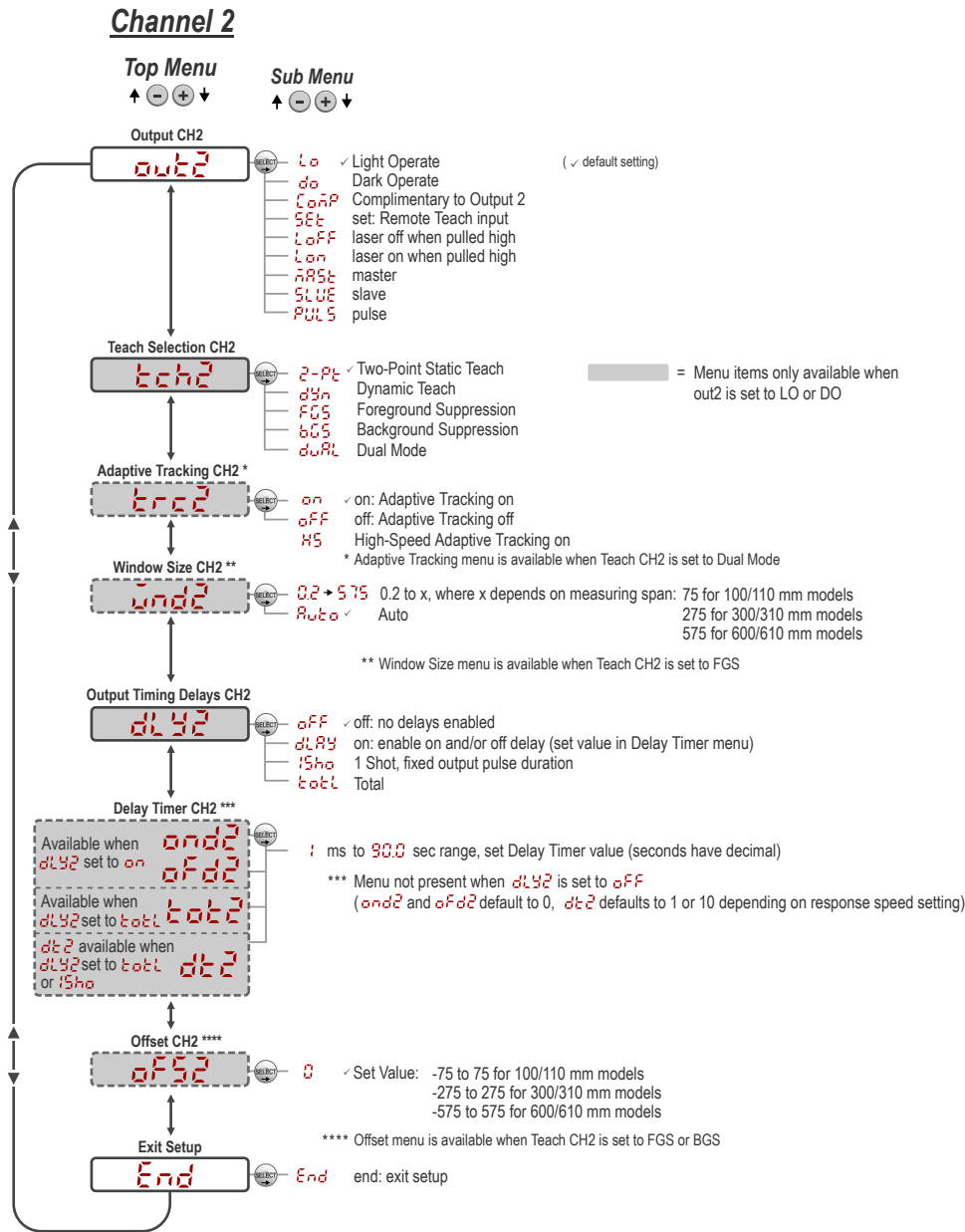

Figure 13. Sensor Menu Map—Channel 2

3.2.1 Output **out1 out2**



Note: The number that follows out on the display indicates which channel is selected.

The Output 1 menu is available in Channel 1. Use this menu to select light operate (LO) or dark operate (DO). The default output configuration is light operate. To switch between light operate and dark operate, select the desired menu option.

- **Lo**—Light operate
- **do**—Dark operate

The Output 2 menu is available in Channel 2. Use this menu to set the output configuration for Channel 2. The default is light operate.

- **Lo**—Light operate
- **do**—Dark operate

- **COMP** —Complementary to output 1
- **SET** —Remote TEACH input
- **LOFF** —Laser off when pulled high
- **L ON** —Laser on when pulled high
- **MAST** —Master sync line output for two-sensor cross-talk avoidance
- **SLVE** —Slave sync line output for two-sensor cross-talk avoidance
- **PULS** —Pulse Frequency Modulation (PFM) output (see [Pulse Frequency Modulation \(PFM\) Output](#) on page 28)

To configure the sensor for master-slave operation, see [Sync Master/Slave](#) on page 28.

3.2.2 TEACH Mode **tch1 tch2**

Use this menu to select the TEACH mode. The default is two-point TEACH. For Channel 2, this menu is available when the output is set to light operate or dark operate.



Note: The number that follows tch on the display indicates which channel is selected.

- **2-PT** —Two-point static background suppression
- **dyn** —Dynamic background suppression
- **FGS** —One-point window (foreground suppression)
- **BGS** —One-point background suppression
- **dual** —Dual (intensity + distance) window

After the TEACH mode is selected, from Run mode, press and hold TEACH for longer than 2 seconds to start the TEACH mode and program the sensor. See [TEACH Procedures](#) on page 19 for additional information and remote input TEACH instructions.

3.2.3 Adaptive Tracking **trc1 trc2**

Use these menus to set the adaptive tracking algorithm. This menu is available only if dual (intensity + distance) mode is selected. For Channel 2, the output must be set to light operate or dark operate.



Note: The number that follows trc on the display indicates which channel is selected.

- **HS** —High-Speed Adaptive Tracking On
- **on** —Adaptive Tracking On (default)
- **off** —Adaptive Tracking Off

3.2.4 Window Size **wnd1 wnd2**

This menu is available only if one-point window (foreground suppression) mode is selected. The default selection is Auto, where the FGS window size is automatically calculated.

This menu can be used to manually set a window size. See the following table for the window size range:

Window Size	Models
0.1 mm to 75 mm	100 mm and 110 mm models
0.2 mm to 275 mm	300 mm and 310 mm models
0.2 mm to 575 mm	600 mm and 610 mm models

This setting is automatically applied during any subsequent teach operation. The window size value represents a +/- mm value, so the total window size is twice this value. For example, a window set of 10 mm gives a 20 mm window centered around the taught point. The window size can also be changed directly from Run mode after changing the setting to any value except Auto. For Channel 2, the output must be set to light operate or dark operate.

3.2.5 Response Speed **SPd** —100/110/300/310 mm Models

Use this menu to select the response speed. The default is 10 milliseconds.

- **15** —1.5 milliseconds
- **3** —3 milliseconds
- **10** —10 milliseconds
- **25** —25 milliseconds
- **50** —50 milliseconds

Table 1: Tradeoffs

Response Speed	Response Speed in Sync Mode	Repeatability	Ambient Light Rejection	Excess Gain
1.5 ms	3 ms	500 µs	Disabled	See Table 13 on page 31
3 ms	6 ms	500 µs	Enabled	
10 ms	20 ms	2 ms	Enabled	
25 ms	50 ms	5 ms	Enabled	
50 ms	100 ms	10 ms	Enabled	

3.2.6 Response Speed **SPd** —600/610 mm Models

Use this menu to select the response speed. The default is 25 milliseconds.

- **2** —2 milliseconds
- **5** —5 milliseconds
- **15** —15 milliseconds
- **25** —25 milliseconds
- **50** —50 milliseconds

Table 2: Tradeoffs

Response Speed	Response Speed in Sync Mode	Repeatability	Ambient Light Rejection	Excess Gain
2 ms	4 ms	800 µs	Disabled	See Table 14 on page 31
5 ms	10 ms	1600 µs	Enabled	
15 ms	30 ms	3 ms	Enabled	
25 ms	50 ms	5 ms	Enabled	
50 ms	100 ms	10 ms	Enabled	

3.2.7 Gain and Sensitivity **GA n**

Use this menu to set the excess gain mode. This menu is only available when a 10, 15, 25, or 50 millisecond response speed is selected. It is not available for 1.5, 2, 3, or 5 millisecond response speeds.

- **HIGH** —High excess gain mode

- **Std** —Standard excess gain mode with increased noise immunity

3.2.8 Output Timing Delays **dLY1 dLY2**

Use this menu to select the output timing delay to be set. On and off delay timers can be used together. The default is no delay. For Channel 2, this menu is available when the output is set to light operate or dark operate.



Note: The number that follows dLY on the display indicates which channel is selected.

- **off** —No delay
- **dLAY** —Delay—enables the selection of on and off delay timers
- **1Sho** —One-shot—enables a one-shot, fixed output pulse duration
- **totL** — Totalizer—enables an output after a defined number of targets are counted

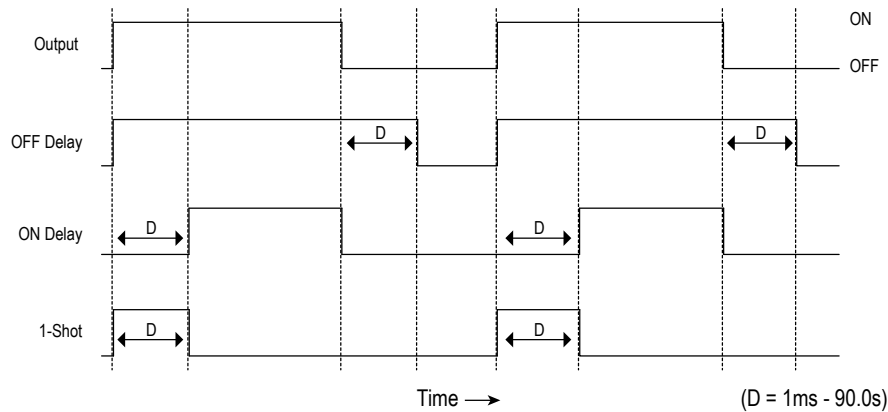

Figure 14. Output Timing Delays

When one of the timing delay options is chosen, the sensor returns to the Setup menu and additional options become available to set the parameter(s):

dLAY

- **ond** —On delay
- **ofd** —Off delay

1Sho

- **dt1 / dt2** —One-shot delay timer



Note: For the one-shot delay timer:

- LO = On pulse when a target is detected inside of the switch point(s)
- DO = On pulse when a target is detected outside of the switch point(s)

totL

- **dt1 / dt2** —Output duration
- **tot1 / tot2** —Number of counts before an output change

Delay Timers **ond1 ond2 ofd2 ofd2 dt1 dt2**

Use these menus to set the delay timers. These menus are available only if an output timing delay is selected.

For **ond** and **ofd**, the default is 0.

For **dt1**, the defaults are:

- 10 milliseconds for 10, 15, 25, and 50 millisecond response speeds
- 1 millisecond for 1.5, 2, 3, and 5 milliseconds response speeds

Use \oplus and \ominus to scroll through the values. Millisecond values do not include the decimal point; seconds values include the decimal point.

- 1 to 999 ms (when $dt1$ is selected, the 1 to 9 ms range is available for 1.5, 2, 3, and 5 ms response times)
- 1.0 to 90.0 s

Totalizer $tot1$

The totalizer function changes the output only after counting a designated number of targets. After selecting this function, $dt1$ or $dt2$ become available to define the output duration and $tot1$ or $tot2$ to define required number of counts before the output changes.

For $tot1$ and $tot2$, the default is 1 count.

For $dt1$ and $dt2$, the default is 10 milliseconds. Use \oplus and \ominus to scroll through the values. Millisecond values do not include the decimal point; seconds values include the decimal point.

- 1 to 999 ms (when $dt1$ or $dt2$ is selected, the 1 to 9 ms range is available for 1.5, 2, 3, and 5 ms response times)
- 1.0 to 90.0 s

From Run mode, press SELECT to change the display to show the current totalizer count. Pressing SELECT again changes the display back to the measured distance.

The totalizer count automatically resets after re-teaching the switch point distance or turning the sensor off.

3.2.9 Zero Reference Location $zero$

Use this menu to select the zero reference location. The default is $near$, 0 = the front of the sensor. This menu is not available in dual (intensity + distance) mode.

- $near$ —0 = the front of the sensor; the measurement increases further from the sensor
- far —0 = maximum range; the measurement increases closer to the sensor

3.2.10 Shift the Zero Reference Location after a TEACH $shift$

Use this menu to select whether the sensor shifts the zero reference location based on the last TEACH process. The default is off , 0 = the front of the sensor or the maximum range. This menu is not available in dual (intensity + distance) mode.

- on —Shift the zero reference location to one of the taught positions with each TEACH
- off —0 = the front of the sensor or the maximum range, depending on the $zero$ setting

This figure illustrates three examples of how changes to the zero and shift settings affect what distance readout is shown on the display when in 2-pt TEACH mode. Changes to the zero setting affect the direction in which the distance increases.

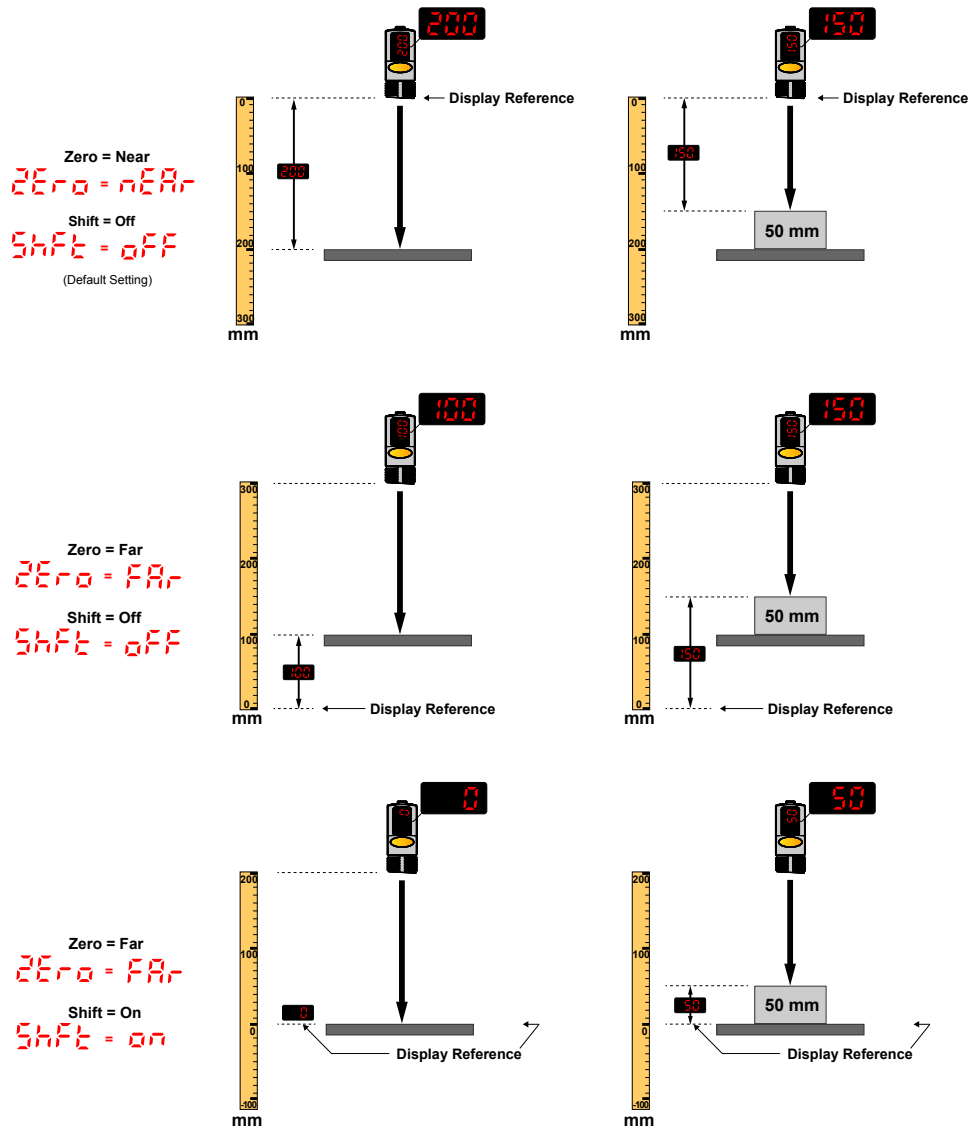

Figure 15. Example Zero and Shift settings

3.2.11 Offset `oFS1` `oFS2`

Use this menu to set an offset from the taught surface. This menu is available only if one-point window (foreground suppression) mode or one-point background suppression mode is selected. For Channel 2, the output must be set to light operate or dark operate.



Note: The number that follows oS on the display indicates which channel is selected.

The offset is automatically calculated or manually defined as a consistently applied value. Auto is the default option. Use +/- to select a value. Values increase or decrease by 0.1 mm (100/110 mm models) or 0.2 mm (300/310/600/610 mm models).





For BGS mode, the default is Auto because the Q4X automatically selects where to position the switch point. For FGS mode, the default is 0 because the window is centered around the taught target.

A positive offset value always shifts the switch point location or the FGS window towards the sensor.

The taught surface must be inside of the defined sensing range. When the teach mode is set to FGS, some portion of the window must be located within the sensing range. When the teach mode is set to BGS, the offset value must be within the defined sensing range. If an offset value falls outside of the sensing range, a message displays. See the applicable TEACH procedure for more information.

3.2.12 Display View

Use this menu to select the display view. The default is right-reading.

-  —Right-reading
-  —Inverted
-  —Right-reading and the display enters sleep mode after 60 seconds
-  —Inverted and the display enters sleep mode after 60 seconds



When the sensor is in sleep mode, the display wakes with the first button press.

3.2.13 Exit Setup Mode

















Navigate to  and press SELECT to exit Setup mode and return to Run mode.

3.2.14 Reset to Factory Defaults



Use this menu to restore the sensor to the factory default settings. See [Factory Default Settings](#) on page 16.





Select  to return to the sensor menu without restoring the defaults. Select  to apply the factory defaults and return to Run mode.

Factory Default Settings

Setting	Factory Default
Delay Timers ()	 —No delay
Display View ()	 —Right-reading, no sleep mode
Gain and Sensitivity ()	 —High excess gain mode
Output ()	 —Light Operate
Response Speed ()	 —10 ms for 100/110 and 300/310 models  —25 ms for 600/610 models
Shift the Zero Reference Location after a TEACH ()	 —0 = the front of the sensor
TEACH Mode ()	 —Two-point TEACH
Zero Reference Location ()	 —Measurement increases further from sensor

3.3 Manual Adjustments

Manually adjust the sensor switch point using the  and  buttons.

1. From Run mode, press either  or  one time. The selected channel displays briefly, then the current switch point value flashes slowly.
2. Press  to move the switch point up or  to move the switch point down. After 1 second of inactivity, the new switch point value flashes rapidly, the new setting is accepted, and the sensor returns to Run mode.



Note: When FGS mode is selected (FGS indicator is on), manual adjustment moves both sides of the symmetrical threshold window simultaneously, expanding and collapsing the window size. Manual adjustment does not move the center point of the window.



Note: When dual mode is selected (DYN, FGS, and BGS indicators are on), after the TEACH process is completed, use the manual adjustment to adjust the sensitivity of the thresholds around the taught reference point. The taught reference point is a combination of the measured distance and returned signal intensity from the reference target. Manual adjustment does not move the taught reference point, but pressing **+** increases the sensitivity, and pressing **-** decreases the sensitivity. When re-positioning the sensor or changing the reference target, re-teach the sensor.

3.4 Remote Input

Remote input is available from the Channel 2 menu. Set Out2 to Set.

Use the remote input to program the sensor remotely. The remote input provides limited programming options and is Active high. For Active high, connect the white input wire to ground (0 V dc), with a remote switch connected between the wire and ground. Pulse the remote input according to the diagram and the instructions provided in this manual.

The length of the individual programming pulses is equal to the value T: 0.04 seconds $T < 0.8$ seconds.

Exit remote programming modes by setting the remote input high for longer than 2 seconds.

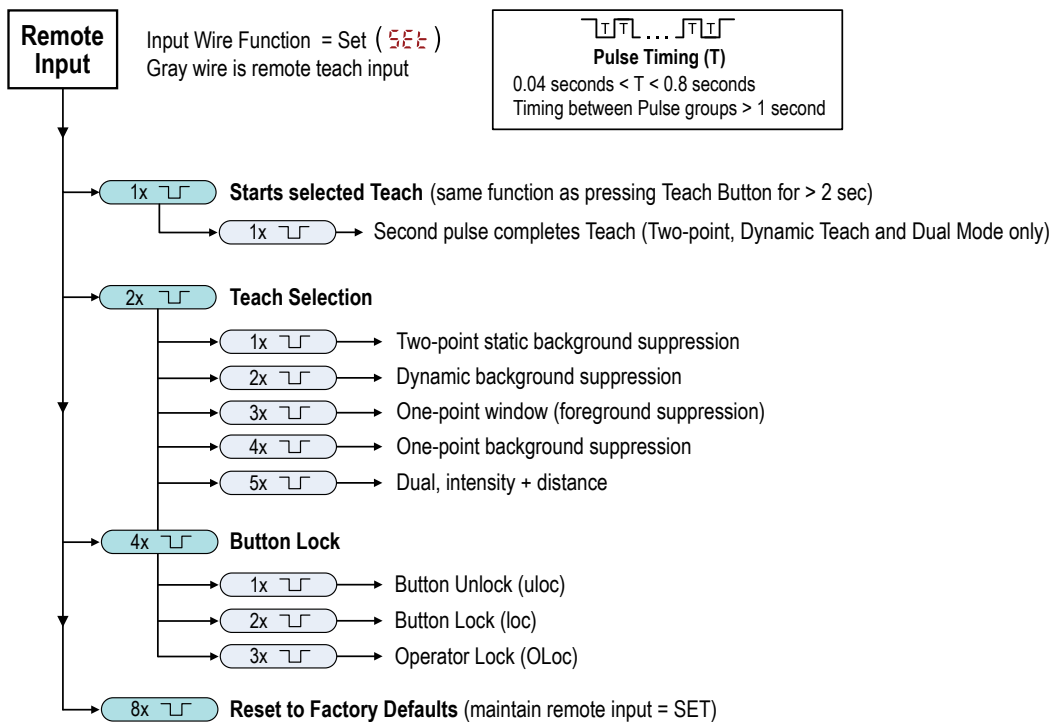



Figure 16. Remote Input Map

3.4.1 Select the TEACH Mode Using the Remote Input

1. Access the TEACH selection.

Action		Result
Double-pulse the remote input.		teach displays.

2. Select the desired TEACH mode.

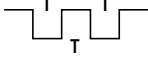
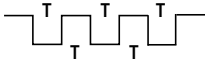
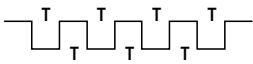
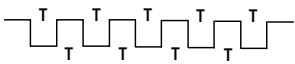
Action		Result
Pulses	TEACH Mode	The selected TEACH method displays for a few seconds and the sensor returns to Run mode.
1 	Two-point static background suppression	
2 	Dynamic background suppression	
3 	One-point window (foreground suppression)	
4 	One-point background suppression	
5 	Dual (intensity + distance)	

3.4.2 Reset to Factory Defaults Using the Remote Input

Eight-pulse the remote input to apply the factory defaults and return to Run mode.

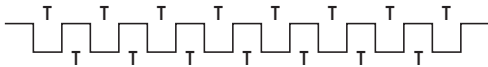

Note: The input wire function remains at remote teach input (**SET**).

3.5 Locking and Unlocking the Sensor Buttons

Use the lock and unlock feature to prevent unauthorized or accidental programming changes. Three settings are available:

- **wLoc** —The sensor is unlocked and all settings can be modified (default).
- **Loc** — The sensor is locked and no changes can be made.
- **OLoc** —The switch point value can be changed by teaching or manual adjustment, but no sensor settings can be changed through the menu.



Note: When the sensor is in either **Loc** or **OLoc** mode, the active channel can be changed using (+)(CH1/CH2).

When in **Loc** mode, **Loc** displays when the (SELECT)(TEACH) button is pressed. The switch point displays when (+)(CH1/CH2) or (-)(MODE) are pressed, but **Loc** displays if the buttons are pressed and held.

When in **OLoc** mode, **Loc** displays when (-)(MODE) is pressed and held. To access the manual adjust options, briefly press and release (+)(CH1/CH2) or (-)(MODE). To enter TEACH mode, press the (SELECT)(TEACH) button and hold for longer than 2 seconds.

Button Instructions

To enter **Loc** mode, hold **+** and press **-** four times. To enter **OLoc** mode, hold **+** and press **-** seven times. Holding **+** and pressing **-** four times unlocks the sensor from either lock mode and the sensor displays **wLoc**.

Remote Input Instructions

1. Access the remote input.

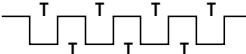
Action		Result
Four-pulse the remote input.		The sensor is ready to have the button state defined and btn displays.

2. Lock or unlock the sensor buttons.

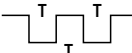
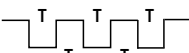
Action		Result
Single-pulse the remote input to unlock the sensor.		uLoc displays and the sensor returns to Run mode.
Double-pulse the remote input to lock the sensor.		Loc displays and the sensor returns to Run mode.
Triple-pulse the remote input to apply the operator lock to the sensor		OLoc displays and the sensor returns to Run mode

3.6 TEACH Procedures

Use the following procedures to teach the sensor.

To cancel a TEACH procedure, press TEACH for longer than 2 seconds, or hold the remote input high for longer than 2 seconds. **cancel** momentarily displays when a TEACH procedure is canceled.

After any teach operation starts, the display temporarily flashes CH1 or CH2 to confirm which channel is currently selected.

3.6.1 Two-Point Static Background Suppression **2-Plt**

Two-point TEACH sets a single switch point. The sensor sets the switch point between two taught target distances, relative to the shifted origin location.

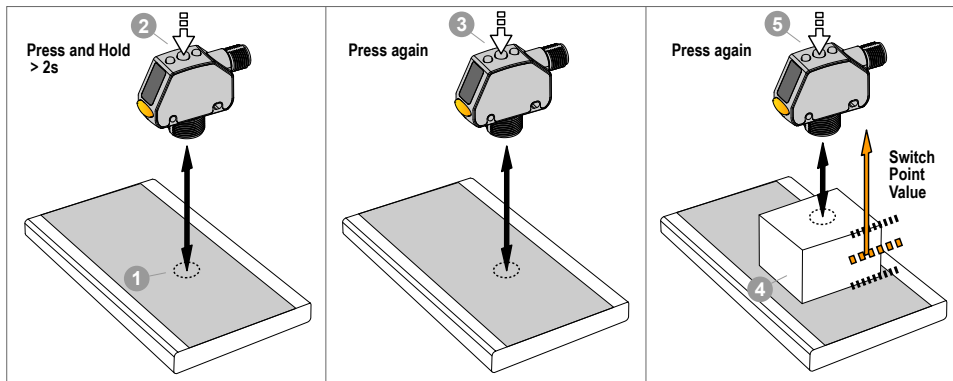

Figure 17. Two-Point Static Background Suppression (Light Operate shown)



Note: The sensor must be set to **tch = 2-Plt** to use the following instructions.



Note: To program the sensor using remote input, remote input must be enabled (**out2 = SET**).

1. Present the target.

Method	Action	Result
Push Button	Present the first target. The sensor-to-target distance must be within the sensor's range.	The target's measurement value displays.
Remote Input		

2. Start the TEACH mode.

Method	Action	Result
Push Button	Press and hold TEACH for longer than 2 seconds.	SET and 1st flash alternately on the display. The DYN, FGS, and BGS indicators flash.
Remote Input	No action required.	N/A

3. Teach the sensor.

Method	Action	Result
Push Button	Press TEACH to teach the target.	The sensor is taught the first target.
Remote Input	Single-pulse the remote input. 	SET , 2nd , and the current distance measurement flash alternately on the display. The DYN, FGS, and BGS indicators flash.

4. Present the target.

Method	Action	Result
Push Button	Present the second target. The sensor-to-target distance must be within the sensor's range.	SET , 2nd , and the distance measurement flash alternately on the display. The DYN, FGS, and BGS indicators flash.
Remote Input		

5. Teach the sensor.

Method	Action	Result
Push Button	Press TEACH to teach the target.	The new switch point flashes rapidly and the sensor returns to Run mode.
Remote Input	Single-pulse the remote input. 	

Table 3: Expected TEACH Behavior for Two-Point Static Background Suppression

See Figure 23 on page 34 for the minimum object separation.

Condition	TEACH Result	Display
Two valid distances that are greater than or equal to the horizontal minimum object separation	Sets a switch point between the two taught distances.	The switch point distance flashes on the display.
Two valid distances that are less than the horizontal minimum object separation	Sets a switch point in front of the furthest taught distance by the horizontal minimum object separation.	BGS and the switch point distance flash alternately on the display.
One valid distance with one invalid TEACH point	Sets a switch point between the one taught distance and the maximum range.	obut and the switch point distance flash alternately on the display.

Condition	TEACH Result	Display														
Two invalid TEACH points	Sets a switch point at the following location: <table border="1" style="margin-left: 20px;"> <thead> <tr> <th>Model</th> <th>Switch Point</th> </tr> </thead> <tbody> <tr> <td>100 mm threaded barrel models</td> <td>99</td> </tr> <tr> <td>300 mm threaded barrel models</td> <td>290</td> </tr> <tr> <td>600 mm threaded barrel models</td> <td>590</td> </tr> <tr> <td>110 mm flush mount models</td> <td>109</td> </tr> <tr> <td>310 mm flush mount models</td> <td>300</td> </tr> <tr> <td>610 mm flush mount models</td> <td>600</td> </tr> </tbody> </table>	Model	Switch Point	100 mm threaded barrel models	99	300 mm threaded barrel models	290	600 mm threaded barrel models	590	110 mm flush mount models	109	310 mm flush mount models	300	610 mm flush mount models	600	Full and the switch point distance flash alternately on the display.
Model	Switch Point															
100 mm threaded barrel models	99															
300 mm threaded barrel models	290															
600 mm threaded barrel models	590															
110 mm flush mount models	109															
310 mm flush mount models	300															
610 mm flush mount models	600															

3.6.2 Dynamic Background Suppression **dyn**

Dynamic TEACH sets a single switch point during machine run conditions. Dynamic TEACH is recommended for applications where a machine or process may not be stopped for teaching. The sensor takes multiple samples and the switch point is set between the minimum and the maximum sampled distances.

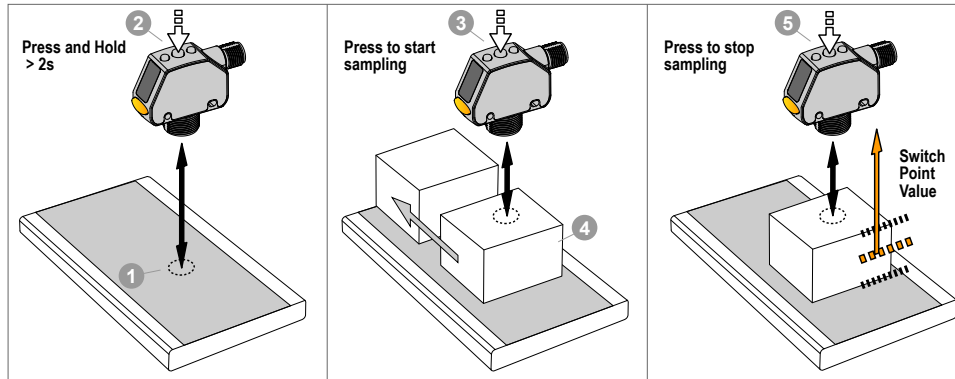

Figure 18. Dynamic Background Suppression



Note: The sensor must be set to **tch = dyn** to use the following instructions. The DYN indicator is amber to indicate Dynamic TEACH mode.



Note: To program the sensor using remote input, remote input must be enabled (**out2 = SET**).

1. Present the target.

Method	Action	Result
Push Button	Present the first target. The sensor-to-target distance must be within the sensor's range.	The target's measurement value displays.
Remote Input		

2. Start the TEACH mode.

Method	Action	Result
Push Button	Press and hold TEACH for longer than 2 seconds.	dyn and Set flash alternately on the display. The DYN indicator flashes.
Remote Input	No action required.	N/A

3. Teach the sensor.

Method	Action	Result
Push Button	Press TEACH to teach the target.	The sensor begins sampling target distance information and dyn and Stop flash alternately on the display. The DYN indicator flashes.
Remote Input	Single-pulse the remote input. 	

4. Present the targets.

Method	Action	Result
Push Button	Present additional targets. The sensor-to-target distance must be within the sensor's range.	The sensor continues to sample target distance information and dyn and Stop flash alternately on the display. The DYN indicator flashes.
Remote Input		

5. Teach the sensor.



Method	Action	Result
Push Button	Press TEACH to stop teaching the sensor.	The new switch point flashes rapidly and the sensor returns to Run mode.
Remote Input	Single-pulse the remote input. 	

Table 4: Expected TEACH Behavior for Dynamic Background Suppression
See Figure 23 on page 34 for the minimum object separation.

Condition	TEACH Result	Display														
Two valid distances that are greater than or equal to the horizontal minimum object separation	Sets a switch point between the two taught distances.	The switch point distance flashes on the display.														
Two valid distances that are less than the horizontal minimum object separation	Sets a switch point in front of the furthest taught distance by the horizontal minimum object separation.	bcs and the switch point distance flash alternately on the display.														
One valid distance with one invalid TEACH point	Sets a switch point between the one taught distance and the maximum range.	obut and the switch point distance flash alternately on the display.														
Two invalid TEACH points	Sets a switch point at the following location:	bcs and the switch point distance flash alternately on the display.														
<table border="1"> <thead> <tr> <th>Model</th> <th>Switch Point</th> </tr> </thead> <tbody> <tr> <td>100 mm threaded barrel models</td> <td>75</td> </tr> <tr> <td>300 mm threaded barrel models</td> <td>200</td> </tr> <tr> <td>600 mm threaded barrel models</td> <td>400</td> </tr> <tr> <td>110 mm flush mount models</td> <td>85</td> </tr> <tr> <td>310 mm flush mount models</td> <td>210</td> </tr> <tr> <td>610 mm flush mount models</td> <td>410</td> </tr> </tbody> </table>		Model	Switch Point	100 mm threaded barrel models	75	300 mm threaded barrel models	200	600 mm threaded barrel models	400	110 mm flush mount models	85	310 mm flush mount models	210	610 mm flush mount models	410	
Model	Switch Point															
100 mm threaded barrel models	75															
300 mm threaded barrel models	200															
600 mm threaded barrel models	400															
110 mm flush mount models	85															
310 mm flush mount models	210															
610 mm flush mount models	410															

3.6.3 One-Point Window (Foreground Suppression) **FCS**

One-point window sets a window (two switch points) centered around the taught target distance. Loss of signal is treated as a detection in One-Point Window mode. The size of the taught window is the vertical minimum object separation. See Figure 23 on page 34.

Manually adjust the window size from Run mode using  and .

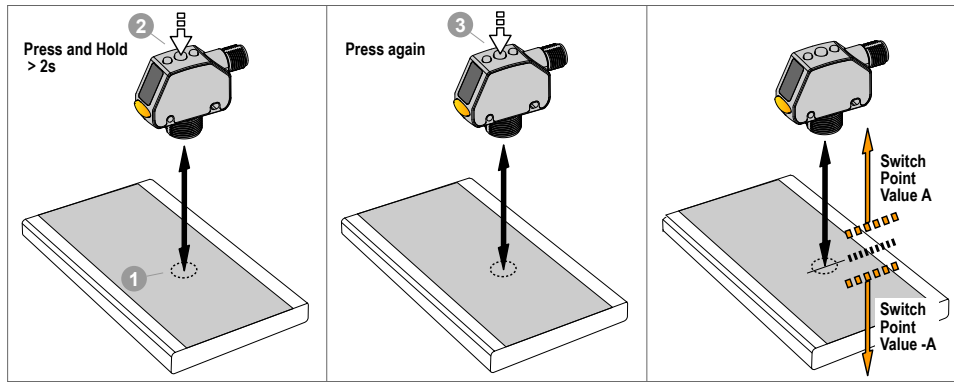

Figure 19. One-Point Window (Foreground Suppression)

In order to reliably detect changes from the taught background, if multiple laser reflections are returning to the sensor, the output status is treated as though the target is outside of the taught window. The display alternates between **2-L** and the measured distance. Realign the laser to avoid light reflecting off of multiple targets if this extra level of verification is not desired.



Note: The sensor must be set to **teah = FGS** to use the following instructions. The FGS indicator is amber to indicate One-Point Window (Foreground Suppression) mode.



Note: To program the sensor using remote input, remote input must be enabled (**out2 = SET**).

1. Present the target.

Method	Action	Result
Push Button	Present the target. The sensor-to-target distance must be within the sensor's range.	The target's measurement value displays.
Remote Input		

2. Start the TEACH mode.

Method	Action	Result
Push Button	Press and hold TEACH for longer than 2 seconds.	<p><u>Light Operate</u></p> <p>SET and on flash alternately on the display. The FGS indicator flashes.</p> <p><u>Dark Operate</u></p> <p>SET and off flash alternately on the display. The FGS indicator flashes.</p>
Remote Input	No action required.	N/A

3. Teach the sensor.

Method	Action	Result
Push Button	Press TEACH to teach the target.	The ± window size flashes rapidly and the sensor returns to Run mode.
Remote Input	Single-pulse the remote input. 	

Table 5: Expected TEACH Behavior for One-Point Window (Foreground Suppression)

See Figure 23 on page 34 for the minimum object separation.

Condition	TEACH Result	Display																						
One valid TEACH point with both switch points in range (with offset, if applicable)	Sets a window (two switch points) centered around the taught distance. The \pm window size is the vertical minimum object separation. The two switch points always stay within the specified sensing range.	The \pm window size flashes on the display.																						
One invalid TEACH Point	<p>Sets a window (two switch points) centered around the following location:</p> <table border="1"> <thead> <tr> <th>Model</th> <th>Window Center Point</th> </tr> </thead> <tbody> <tr> <td>100 mm threaded barrel models</td> <td>80</td> </tr> <tr> <td>300 mm threaded barrel models</td> <td>250</td> </tr> <tr> <td>600 mm threaded barrel models</td> <td>500</td> </tr> <tr> <td>110 mm flush mount models</td> <td>90</td> </tr> <tr> <td>310 mm flush mount models</td> <td>260</td> </tr> <tr> <td>610 mm flush mount models</td> <td>510</td> </tr> </tbody> </table> <p>The window size is:</p> <table border="1"> <thead> <tr> <th>Model</th> <th>Window Size</th> </tr> </thead> <tbody> <tr> <td>100 mm threaded barrel and 110 mm flush mount models</td> <td>± 12.5 mm</td> </tr> <tr> <td>300 mm threaded barrel and 310 mm flush mount models</td> <td>± 25 mm</td> </tr> <tr> <td>600 mm threaded barrel and 610 mm flush mount models</td> <td>± 25 mm</td> </tr> </tbody> </table>	Model	Window Center Point	100 mm threaded barrel models	80	300 mm threaded barrel models	250	600 mm threaded barrel models	500	110 mm flush mount models	90	310 mm flush mount models	260	610 mm flush mount models	510	Model	Window Size	100 mm threaded barrel and 110 mm flush mount models	± 12.5 mm	300 mm threaded barrel and 310 mm flush mount models	± 25 mm	600 mm threaded barrel and 610 mm flush mount models	± 25 mm	<p>----- and the window center point distance flash alternately on the display.</p>
Model	Window Center Point																							
100 mm threaded barrel models	80																							
300 mm threaded barrel models	250																							
600 mm threaded barrel models	500																							
110 mm flush mount models	90																							
310 mm flush mount models	260																							
610 mm flush mount models	510																							
Model	Window Size																							
100 mm threaded barrel and 110 mm flush mount models	± 12.5 mm																							
300 mm threaded barrel and 310 mm flush mount models	± 25 mm																							
600 mm threaded barrel and 610 mm flush mount models	± 25 mm																							
One valid TEACH point with one switch point within range and one switch point out of range (with offset, if applicable)	Sets a window (two switch points) that is centered at the TEACH point (after offset, if applicable) with one switch point at the maximum range.	<p>----- and the \pm window size flash alternately on the display.</p>																						

Condition	TEACH Result	Display																						
One valid TEACH point that, after the offset, results in a both switch points outside of the range	<p>Sets a window (two switch points) centered around the following location:</p> <table border="1"> <thead> <tr> <th>Model</th> <th>Window Center Point</th> </tr> </thead> <tbody> <tr> <td>100 mm threaded barrel models</td> <td>80</td> </tr> <tr> <td>300 mm threaded barrel models</td> <td>250</td> </tr> <tr> <td>600 mm threaded barrel models</td> <td>500</td> </tr> <tr> <td>110 mm flush mount models</td> <td>90</td> </tr> <tr> <td>310 mm flush mount models</td> <td>260</td> </tr> <tr> <td>610 mm flush mount models</td> <td>510</td> </tr> </tbody> </table> <p>The window size is:</p> <table border="1"> <thead> <tr> <th>Model</th> <th>Window Size</th> </tr> </thead> <tbody> <tr> <td>100 mm threaded barrel and 110 mm flush mount models</td> <td>±12.5 mm</td> </tr> <tr> <td>300 mm threaded barrel and 310 mm flush mount models</td> <td>± 25 mm</td> </tr> <tr> <td>600 mm threaded barrel and 610 mm flush mount models</td> <td>± 25 mm</td> </tr> </tbody> </table>	Model	Window Center Point	100 mm threaded barrel models	80	300 mm threaded barrel models	250	600 mm threaded barrel models	500	110 mm flush mount models	90	310 mm flush mount models	260	610 mm flush mount models	510	Model	Window Size	100 mm threaded barrel and 110 mm flush mount models	±12.5 mm	300 mm threaded barrel and 310 mm flush mount models	± 25 mm	600 mm threaded barrel and 610 mm flush mount models	± 25 mm	<p>OFF and the window center point distance flash alternately on the display.</p>
Model	Window Center Point																							
100 mm threaded barrel models	80																							
300 mm threaded barrel models	250																							
600 mm threaded barrel models	500																							
110 mm flush mount models	90																							
310 mm flush mount models	260																							
610 mm flush mount models	510																							
Model	Window Size																							
100 mm threaded barrel and 110 mm flush mount models	±12.5 mm																							
300 mm threaded barrel and 310 mm flush mount models	± 25 mm																							
600 mm threaded barrel and 610 mm flush mount models	± 25 mm																							

3.6.4 One-Point Background Suppression **bGS**

One-point background suppression sets a single switch point in front of the taught target distance. Objects beyond the taught switch point are ignored. The switch point is set in front of the taught target distance by the vertical minimum object separation. See [Figure 23](#) on page 34.

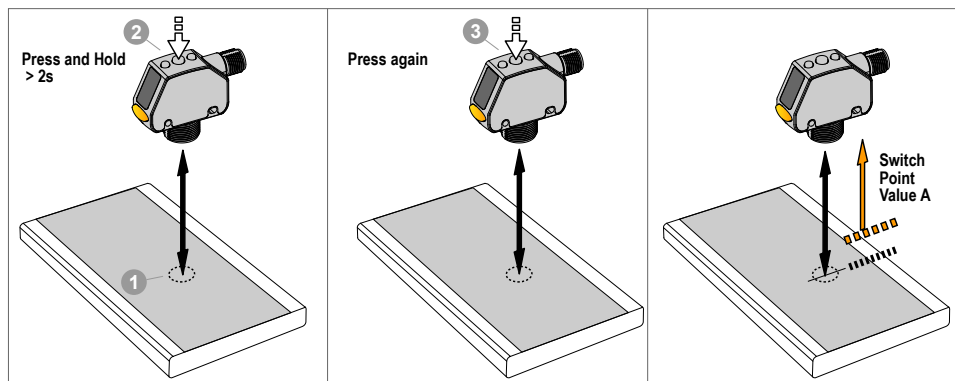

Figure 20. One-Point Background Suppression



Note: The sensor must be set to **tch = bGS** to use the following instructions. The BGS indicator is amber to indicate Background Suppression mode.



Note: To program the sensor using remote input, remote input must be enabled (**out2 = SET**).

1. Present the target.

Method	Action	Result
Push Button	Present the target. The sensor-to-target distance must be within the sensor's range.	The target's measurement value displays.
Remote Input		

2. Start the TEACH mode.

Method	Action	Result
Push Button	Press and hold TEACH for longer than 2 seconds.	<p><u>Light Operate</u></p> <p>SET and OFF flash alternately on the display. The BGS indicator flashes.</p> <p><u>Dark Operate</u></p> <p>SET and ON flash alternately on the display. The BGS indicator flashes.</p>
Remote Input	No action required.	N/A

3. Teach the sensor.

Method	Action	Result
Push Button	Press TEACH to teach the target.	The new switch point flashes rapidly and the sensor returns to Run mode.
Remote Input	Single-pulse the remote input. 	

Table 6: Expected TEACH Behavior for One-Point Background Suppression
See [Figure 23](#) on page 34 for the minimum object separation.

Condition	TEACH Result	Display														
One valid TEACH point If an Offset is applied, the TEACH point is still valid	Sets a switch point in front of the taught distance by the vertical minimum object separation.	The switch point distance flashes on the display.														
One invalid TEACH point	<p>Sets a switch point at the following location:</p> <table border="1"> <thead> <tr> <th>Model</th> <th>Switch Point</th> </tr> </thead> <tbody> <tr> <td>100 mm threaded barrel models</td> <td>75</td> </tr> <tr> <td>300 mm threaded barrel models</td> <td>200</td> </tr> <tr> <td>600 mm threaded barrel models</td> <td>400</td> </tr> <tr> <td>110 mm flush mount models</td> <td>85</td> </tr> <tr> <td>310 mm flush mount models</td> <td>210</td> </tr> <tr> <td>610 mm flush mount models</td> <td>410</td> </tr> </tbody> </table>	Model	Switch Point	100 mm threaded barrel models	75	300 mm threaded barrel models	200	600 mm threaded barrel models	400	110 mm flush mount models	85	310 mm flush mount models	210	610 mm flush mount models	410	BGS and the switch point distance flash alternately on the display.
Model	Switch Point															
100 mm threaded barrel models	75															
300 mm threaded barrel models	200															
600 mm threaded barrel models	400															
110 mm flush mount models	85															
310 mm flush mount models	210															
610 mm flush mount models	410															

Condition	TEACH Result	Display														
One valid TEACH point that, after offset, becomes invalid	Sets a switch point at the following location: <table border="1" style="margin: 5px auto;"> <thead> <tr> <th>Model</th> <th>Switch Point</th> </tr> </thead> <tbody> <tr> <td>100 mm threaded barrel models</td> <td>75</td> </tr> <tr> <td>300 mm threaded barrel models</td> <td>200</td> </tr> <tr> <td>600 mm threaded barrel models</td> <td>400</td> </tr> <tr> <td>110 mm flush mount models</td> <td>85</td> </tr> <tr> <td>310 mm flush mount models</td> <td>210</td> </tr> <tr> <td>610 mm flush mount models</td> <td>410</td> </tr> </tbody> </table>	Model	Switch Point	100 mm threaded barrel models	75	300 mm threaded barrel models	200	600 mm threaded barrel models	400	110 mm flush mount models	85	310 mm flush mount models	210	610 mm flush mount models	410	oFSt and the switch point distance flash alternately on the display.
Model	Switch Point															
100 mm threaded barrel models	75															
300 mm threaded barrel models	200															
600 mm threaded barrel models	400															
110 mm flush mount models	85															
310 mm flush mount models	210															
610 mm flush mount models	410															

3.6.5 Dual (Intensity + Distance) **duAL**

Dual (intensity + distance) TEACH records the distance and amount of light received from the reference surface. The output switches when an object passing between the sensor and the reference surface changes the perceived distance or amount of returned light. For more information on dual TEACH mode, see [Dual \(Intensity + Distance\) Mode](#) on page 36.



Note: To use the following instructions, set the sensor to **teCh = duAL**. The DYN, FGS, and BGS indicators are amber.



Note: To program the sensor using remote input, remote input must be enabled (**out2 = SEt**).

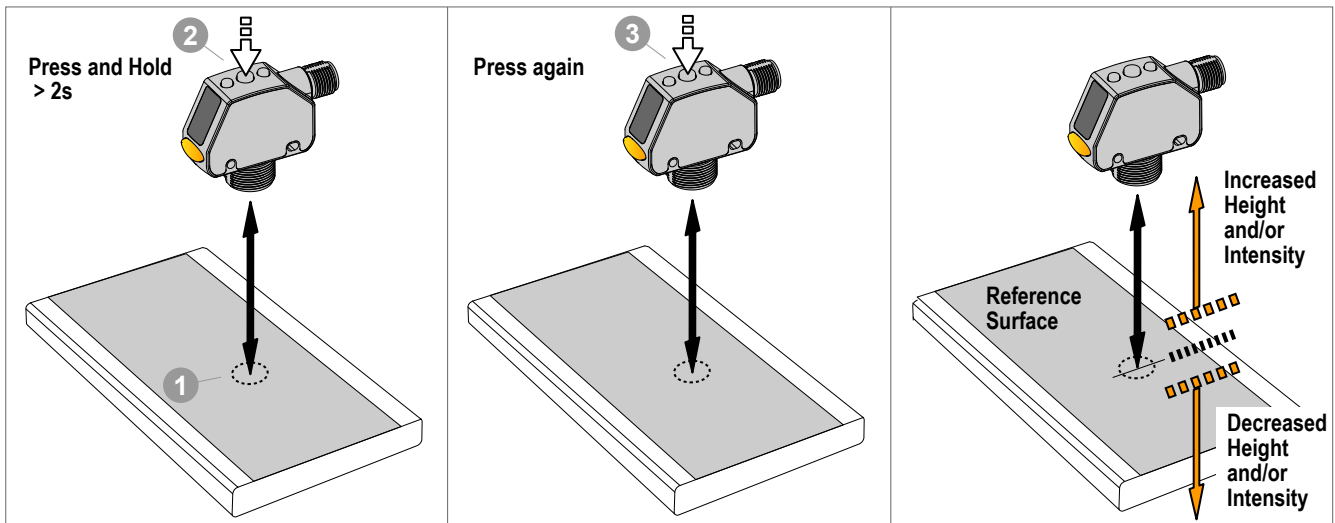

1. Present the target.

Method	Action	Result
Push Button Remote Input	Present the reference target.	The target's match percentage displays

2. Start the TEACH mode.

Method	Action	Result
Push Button	Press and hold the TEACH button for more than 2 seconds.	Light Operate: SET and on flash on the display. The DYN, FGS, and BGS indicators flash. Dark Operate: SET and off flash on the display. The DYN, FGS, and BGS indicators flash.
Remote Input	No action required.	N/A

3. Teach the sensor.

Method	Action	Result
Push Button	Press the TEACH button.	The switching threshold flashes rapidly and the sensor returns to Run mode.
Remote Input	Single-pulse the remote input. 	

Table 7: Expected TEACH Behavior for Dual (Intensity + Distance) Mode

Condition	TEACH Result	Display
One valid reference surface is taught within sensing range	Sets a dual (intensity + distance) window centered around the taught reference surface. The ± window size is the previously used switching threshold, or 75% by default.	The switching threshold flashes on the display.
One reference surface is taught outside the sensing range	Sets a dual (intensity + distance) window centered around the taught reference surface that is outside the sensing range. The sensing conditions may not be as reliable.	out flashes on the display.
One invalid TEACH Point	No reference surface is taught, the output will change when any object is detected.	FULL flashes on the display.

3.7 Pulse Frequency Modulation (PFM) Output **PULS**

The Q4X can generate pulses whose frequency are proportional to the sensor's measured distance, thereby providing a method for representing an analog signal with only a discrete counter. The sensing range of the sensor is scaled from 100 to 600 Hz (100 Hz equals the near range limit of the sensor, 600 Hz equals the far sensing range limit). An output of 50 Hz represents a Loss of Signal (**LOS**) condition where there is no target or the target is out of the sensor's range.

3.8 Sync Master/Slave

Two Q4X sensors may be used together in a single sensing application. To eliminate crosstalk between the two sensors, configure one sensor to be the master and one to be the slave. In this mode, the sensors alternate taking measurements and the response speed doubles.



Important: The master sensor and the slave sensor must be programmed for the same Response Speed and Gain and Sensitivity settings. The master sensor and slave sensor must share a common power source.

1. Configure the first sensor as the master; navigate: **out2** > **MAST** .
2. Configure the second sensor as the slave; navigate: **out2** > **SLVE** .
3. Connect the gray (input) wires of the two sensors together.

4 IO-Link Interface

IO-Link is a point-to-point communication link between a master device and sensor. It can be used to automatically parameterize sensors and transmit process data. For the latest IO-Link protocol and specifications, please visit the web site at <http://www.io-link.com>.

The IO-Link IODD package (P/N 196929) is contained on the Banner Website at <http://www.bannerengineering.com>.

5 Specifications

Sensing Beam

Visible red Class 1 laser, 655 nm

Supply Voltage (Vcc)

10 to 30 V dc (Class 2 supply) (10% max ripple within limits)

Power and Current Consumption, exclusive of load
< 700 mW

Sensing Range—Threaded Barrel Models

600 mm models: 25 mm to 600 mm (0.98 in to 23.62 in)

300 mm models: 25 mm to 300 mm (0.98 in to 11.81 in)

100 mm models: 25 mm to 100 mm (0.98 in to 3.94 in)

Sensing Range—Flush Mount Models

610 mm models: 35 mm to 610 mm (1.38 in to 24.02 in)

310 mm models: 35 mm to 310 mm (1.38 in to 12.20 in)

110 mm models: 35 mm to 110 mm (1.38 in to 4.33 in)

Output Configuration

First output = IO-Link, Push/pull

Secondary output = PNP only output or input, or pulse frequency modulated output

Output Rating

100 mA max capability each output

100 mA max total load current for sensor

Saturation: < 2 V

Off-state leakage current: < 50 µA PNP at 30 V (N.A. push/pull)

Discrete Output Distance Repeatability

Table 8: 600/610 mm Models

Distance (mm)		Repeatability
Threaded Barrel Models	Flush Mount Models	
25 to 100 mm	35 to 110 mm	± 0.5 mm
100 to 600 mm	110 to 610 mm	± 0.5%

Table 9: 300/310 mm Models

Distance (mm)		Repeatability
Threaded Barrel Models	Flush Mount Models	
25 to 50 mm	35 to 60 mm	± 0.5 mm
50 to 300 mm	60 to 310 mm	± 1% of range

Table 10: 100/110 mm Models

Distance (mm)		Repeatability
Threaded Barrel Models	Flush Mount Models	
25 to 100 mm	35 to 110 mm	+/-0.2 mm

Remote Input

Allowable Input Voltage Range: 0 to Vcc

Active High (internal weak pulldown): High state > (VCC - 2 V) @ 1.5 mA max.

Supply/Output Protection Circuitry

Protected against reverse polarity and transient overvoltages

Response Speed

User selectable, 100, 110, 300, and 310 mm models:

- 15 —1.5 milliseconds
- 3 —3 milliseconds
- 10 —10 milliseconds
- 25 —25 milliseconds
- 50 —50 milliseconds

User selectable, 600 and 610 mm models:

- 2 —2 milliseconds
- 5 —5 milliseconds
- 15 —15 milliseconds
- 25 —25 milliseconds
- 50 —50 milliseconds

Delay at Power Up

100, 110, 300, 310 mm models: < 750 ms

600, 610 mm models: < 1.5 s

Maximum Torque

Side mounting: 1 N-m (9 in-lbs)

Nose mounting: 20 N-m (177 in-lbs)

Ambient Light Immunity

> 5,000 lux at 300 mm

> 2,000 lux at 600 mm

Connector

Integral 4-pin M12/Euro-style male quick disconnect (QD)

Construction

Housing: 316 L stainless steel

Lens cover: PMMA acrylic

Lightpipe and display window: polysulfone

Temperature Effect

0.05 mm/°C at < 125 mm (threaded barrel models)/< 135 mm (flush mount models)

0.35 mm/°C at 300 mm (threaded barrel models)/310 mm (flush mount models)

1.0 mm/°C at 600 mm (threaded barrel models)/ 610 mm (flush mount models)

Chemical Compatibility

Compatible with commonly used acidic or caustic cleaning and disinfecting chemicals used in equipment cleaning and sanitation. ECOLAB® certified.

Compatible with typical cutting fluids and lubricating fluids used in machining centers

IO-Link Interface

Supports Smart Sensor **Profile**: Yes

Baud Rate: 38400 bps

Process Data Widths: 16 bits

IODD **files**: Provides all programming options of the display, plus additional functionality.

Application Note

For optimum performance, allow 10 minutes for the sensor to warm up

Beam Spot Size—100/110 mm Models

Table 11: Beam Spot Size—100/110 mm Models

Distance (mm)		Size (Horizontal × Vertical)
Threaded Barrel Models	Flush Mount Models	
25	35	2.4 mm × 1.0 mm
50	60	2.2 mm × 0.9 mm
100	110	1.8 mm × 0.7 mm

Beam Spot Size—300/310 mm and 600/610 mm Models

Table 12: Beam Spot Size—300/310 mm and 600/610 mm Models

Distance (mm)		Size (Horizontal × Vertical)
Threaded Barrel Models	Flush Mount Models	
25	35	2.6 mm × 1.0 mm
150	160	2.3 mm × 0.9 mm
300	310	2.0 mm × 0.8 mm
600	610	1.9 mm × 1.0 mm

Excess Gain using a 90% White Card—100/110/300/310 mm Models

Table 13: **High** Excess Gain (**Std** Excess Gain¹)

Response Speed (ms)	· at 25 mm (100/300 mm models)	· at 100 mm (100/300 mm models)	· at 300 mm (100/300 mm models)
	· at 35 mm (110/310 mm models)	· at 110 mm (110/310 mm models)	· at 310 mm (110/310 mm models)
1.5	200	100	20
3	200	100	20
10	1000 (500)	500 (250)	100 (50)
25	2500 (1000)	1250 (500)	250 (100)
50	5000 (2500)	2500 (1250)	500 (250)

Excess Gain using a 90% White Card—600/610 mm Models

Table 14: **High** Excess Gain (**Std** Excess Gain²)

Response Speed (ms)	· at 25 mm (600 mm models)	· at 100 mm (600 mm models)	· at 300 mm (600 mm models)	· at 600 mm (600 mm models)
	· at 35 mm (610 mm models)	· at 110 mm (610 mm models)	· at 310 mm (610 mm models)	· at 610 mm (610 mm models)
2	280	110	25	6
5	280	110	25	6
15	1000 (360)	400 (150)	80 (30)	20 (7)
25	2000 (1000)	800 (400)	160 (80)	40 (20)
50	4000 (2000)	1600 (800)	320 (160)	80 (40)

Environmental Rating

- IEC IP67 per IEC60529
- IEC IP68 per IEC60529
- IEC IP69K per DIN40050-9

Vibration

MIL-STD-202G, Method 201A (10 Hz to 60 Hz, 0.06 inch (1.52 mm) double amplitude, 2 hours each along X, Y and Z axes), with sensor operating

Shock

MIL-STD-202G, Method 213B, Condition I (100G 6x along X, Y and Z axes, 18 total shocks), with sensor operating

Operating Conditions

- 10 °C to +50 °C (+14 °F to +122 °F)
- 35% to 95% relative humidity

Storage Temperature

- 25 °C to +75 °C (-13 °F to +167 °F)

¹ · **Std** excess gain available in 10 ms, 25 ms, and 50 ms response speeds only

· **Std** excess gain provides increased noise immunity

² · **Std** excess gain available in 15 ms response speed only

· **Std** excess gain provides increased noise immunity

Required Overcurrent Protection



WARNING: Electrical connections must be made by qualified personnel in accordance with local and national electrical codes and regulations.

Overcurrent protection is required to be provided by end product application per the supplied table.

Overcurrent protection may be provided with external fusing or via Current Limiting, Class 2 Power Supply.

Supply wiring leads < 24 AWG shall not be spliced.

For additional product support, go to www.bannerengineering.com.

Supply Wiring (AWG)	Required Overcurrent Protection (Amps)
20	5.0
22	3.0
24	2.0
26	1.0
28	0.8
30	0.5

Certifications



Class 2 power

UL Environmental Rating: Type 1



chemical compatibility certified

ECOLAB is a registered trademark of Ecolab USA Inc. All rights reserved.

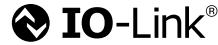

5.1 Dimensions

All measurements are listed in millimeters [inches], unless noted otherwise.

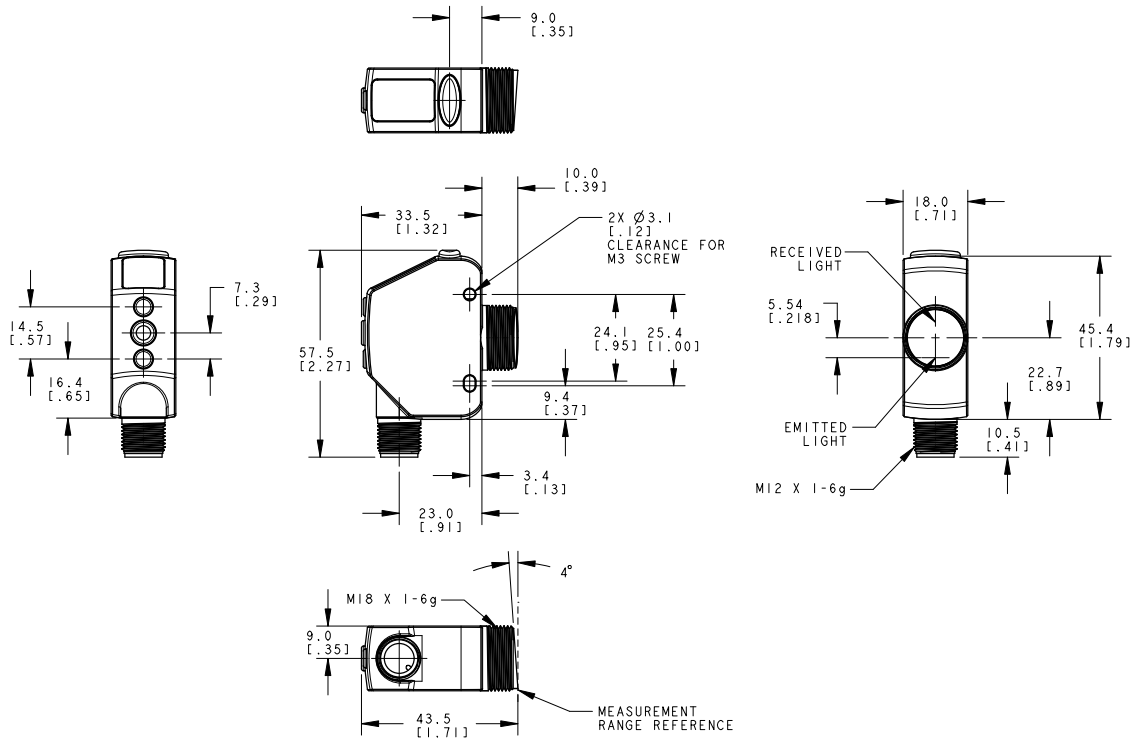

Figure 21. Threaded Barrel Models

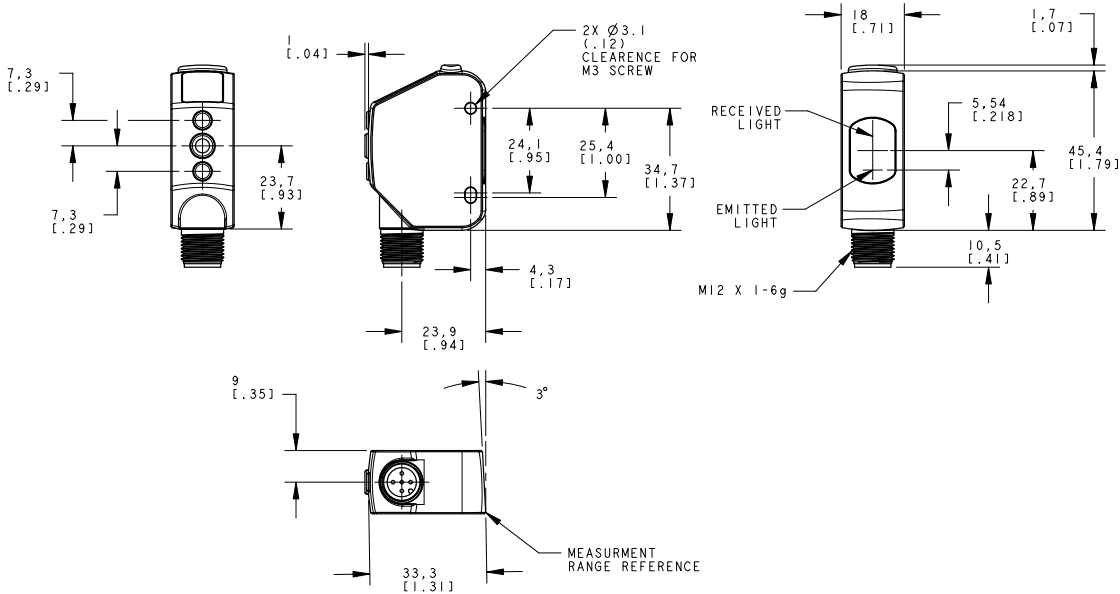

Figure 22. Flush Mount Models

5.2 Performance Curves—Threaded Barrel Models

Minimum Separation Distance Between Target and Background for: Uniform and Non-Uniform Targets

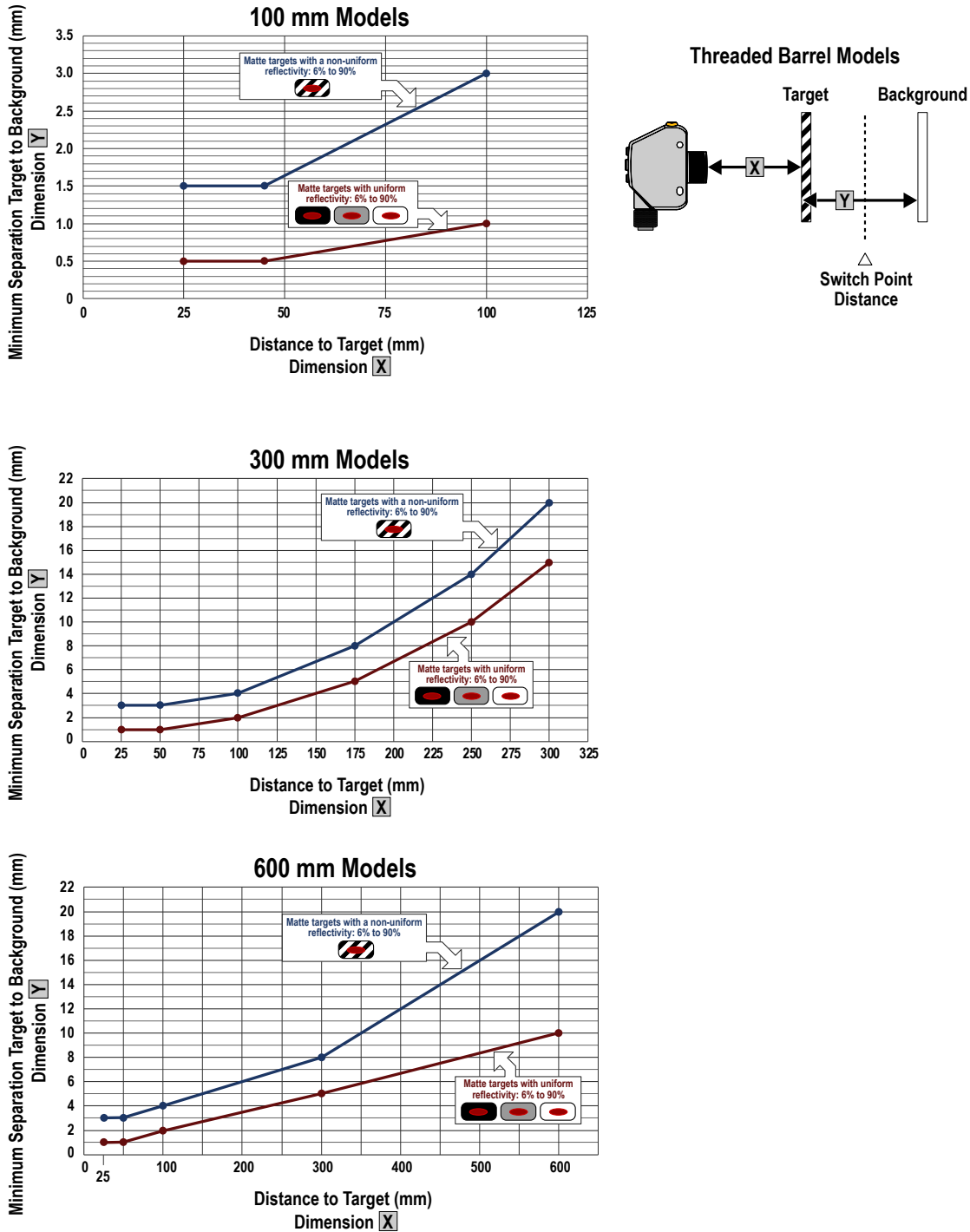

Figure 23. Minimum Object Separation Distance (90% to 6% reflectance)

5.3 Performance Curves—Flush Mount Models

Minimum Separation Distance Between Target and Background for: Uniform and Non-Uniform Targets

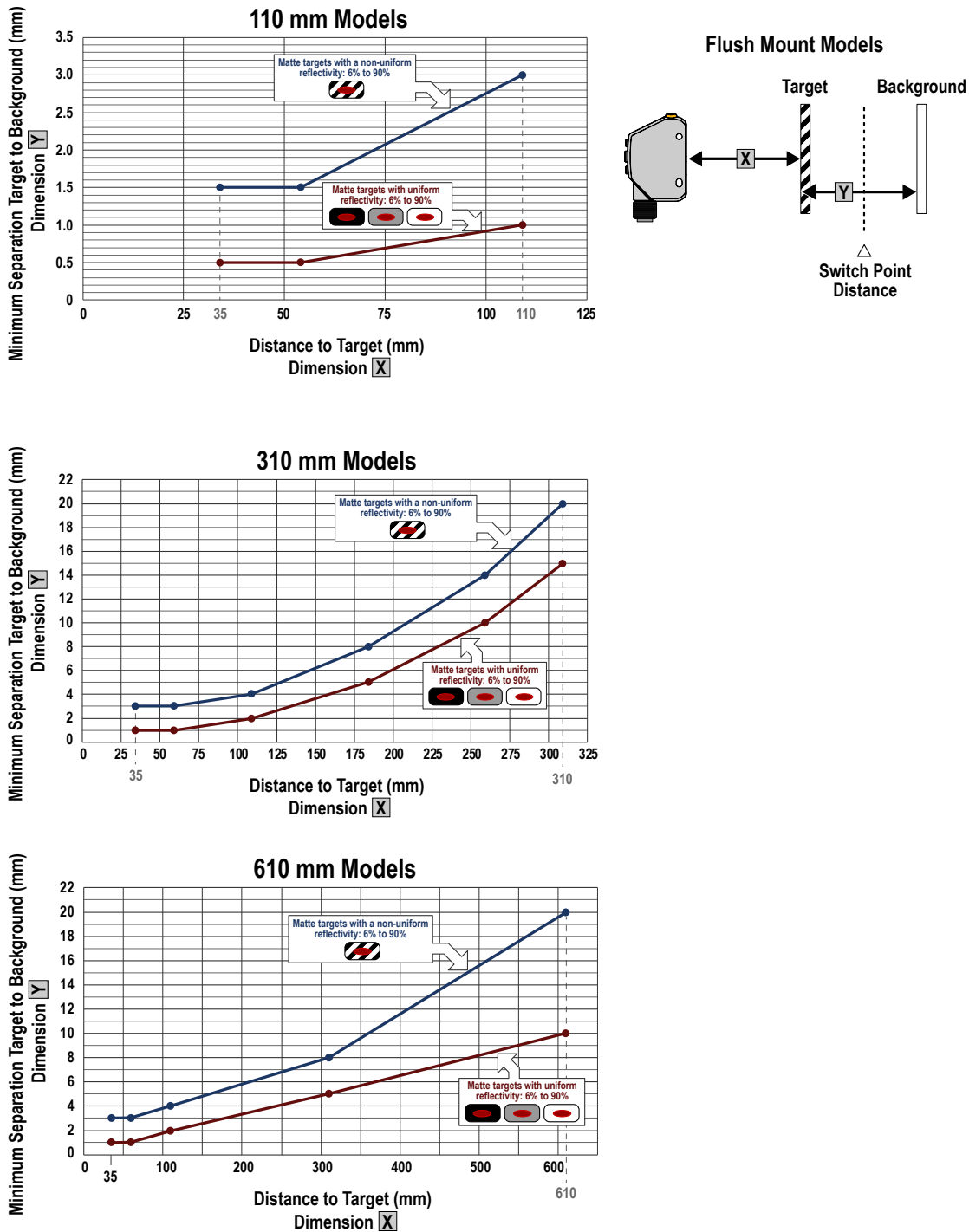

Figure 24. Minimum Object Separation Distance (90% to 6% reflectance)

6 Additional Information

6.1 Dual (Intensity + Distance) Mode

In background suppression (DYN, 1-pt, 2-pt) and foreground suppression (FGS) TEACH modes, the Q4X sensor compares changes in the measured distance between the sensor and target to control the output state. Dual TEACH mode, dual intensity + distance window, expands the applications the Q4X can solve by combining distance-based detection with light intensity thresholds. In dual TEACH mode, the user teaches the Q4X a fixed reference surface, and the sensor compares intensity and distance readings against the reference surface it was taught. After teaching the reference target, the displayed value is calibrated to 100P, or a 100% match. When an object enters the sensor's field of view, the degree of consistency with the reference surface becomes lower and causes a change in sensor output.

In dual mode, you can detect when the target is present at the right distance and when it returns the right amount of light. This is useful in **error-proofing** applications where you need to know not only that the part is present (distance), but also that it is the correct part (intensity).

In dual mode, the Q4X requires a reference surface (far left). Once taught, the distance and intensity of the reference surface are recorded and used as a baseline. A user adjustable switching threshold is set, and changes in distance and/or intensity outside the switching threshold creates a sensor output change. The example above uses a 90% (90P) match condition with a 10% change in intensity and/or distance from the reference surface required to change the output state. The default-switching threshold is a 75% match to the reference condition (75P); this sets the threshold 25% from the distance and intensity of the reference surface. A transparent object can be detected either by a change in intensity, distance, or by a double peak reflection (far right). When a double peak reflection is detected, the display alternates between **2-L** and the percent match.

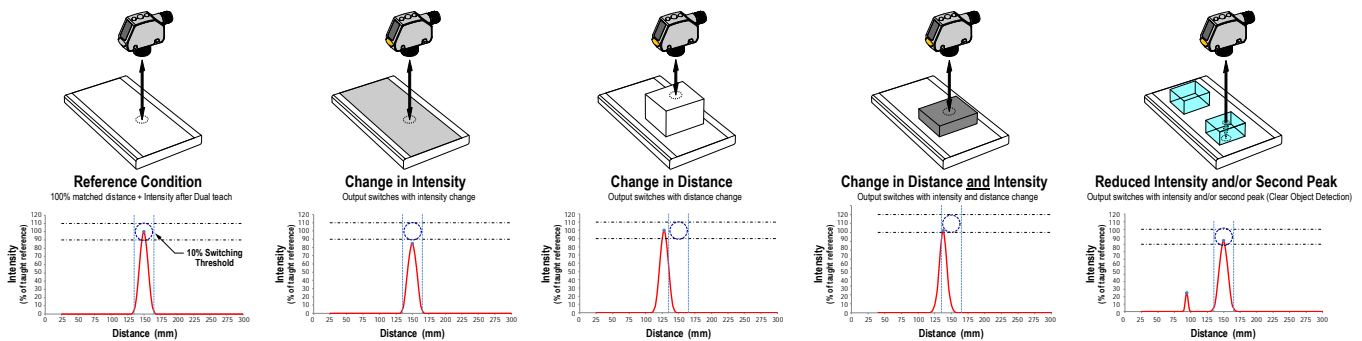

The Q4X sensor can be taught non-ideal reference surfaces, such as surfaces outside of the sensor's range, very dark surfaces, or even empty space. These situations may enable applications requiring a long range detection but are subject to typical diffuse mode detection challenges.

6.2 Dual Mode Reference Surface Considerations

Optimize reliable detection by applying these principals when selecting your reference surface, positioning your sensor relative to the reference surface, and presenting your target. The robust detection capabilities of the Q4X allows successful detection even under non-ideal conditions in many cases. Typical reference surfaces are metal machine frames, conveyor side rails, or mounted plastic targets. Contact Banner Engineering if you require assistance setting up a stable reference surface in your application.

1. Select a reference surface with these characteristics where possible:
 - Matte or diffuse surface finish
 - Fixed surface with no vibration
 - Dry surface with no build-up of oil, water, or dust
2. Position the reference surface between 50 mm and the maximum sensing range for threaded barrel models or between 60 mm and the maximum sensing range for flush mount models.
3. Position the target to be detected as close to the sensor as possible, and as far away from the reference surface as possible.
4. Angle the sensing beam relative to the target and relative to the reference surface 10 degrees or more.

6.3 Dual Mode Considerations for Clear and Transparent Object Detection

The Q4X is able to detect the very small changes caused by transparent and clear objects. A transparent object can be detected either by a change in intensity, distance, or by a double-peak reflection.

The Q4X sensor can be taught non-ideal reference surfaces, such as surfaces outside of the sensor range or very dark surfaces. Teaching non-ideal reference surfaces may enable applications other than transparent or clear object detection, but best results for transparent or clear object detection require a stable reference surface.

The display shows the match percentage to the taught reference point. The user adjustable switch point defines the sensitivity and the output switches when the match percentage to the reference point crosses the switch point. Your specific application may require fine tuning of the switch point, but these values are the recommended starting values:

Switch point (%)	Typical Applications
75 (default)	Default, recommended for PET bottles and Trays
88	Recommended for thin films
50	Recommended for tinted brown, tinted green, or water-filled containers

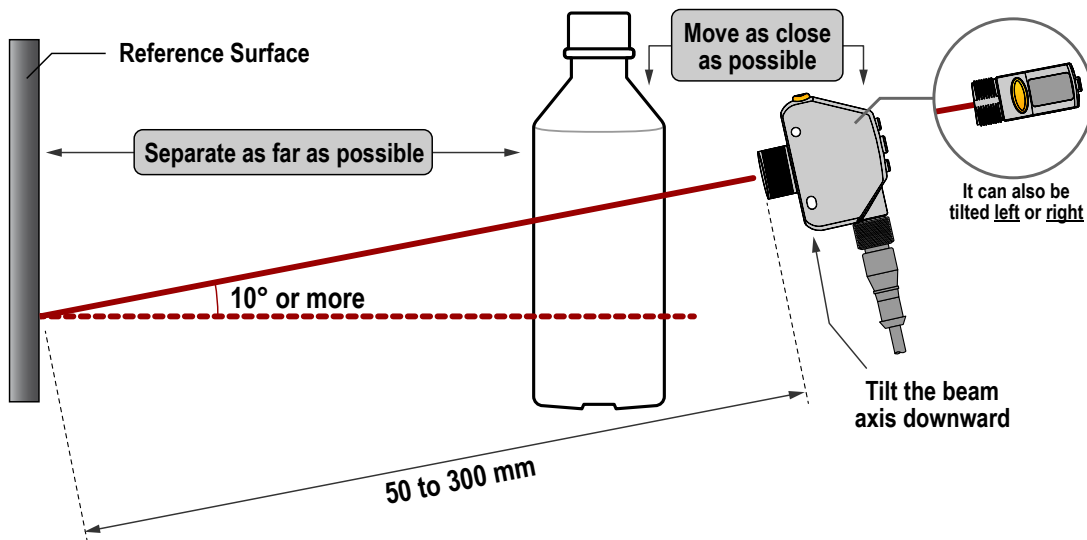
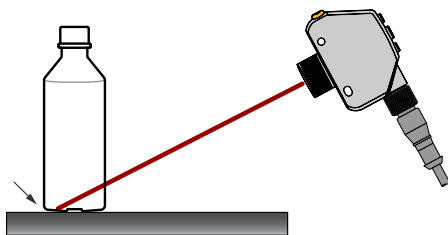
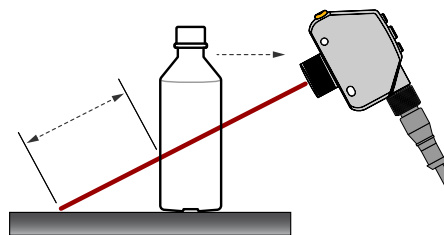

Figure 25. Example mounting considerations

PROBLEM:
The object is close to the reference surface



SOLUTION:
Move the target closer to the sensor



PROBLEM:
The sensor is far from the object

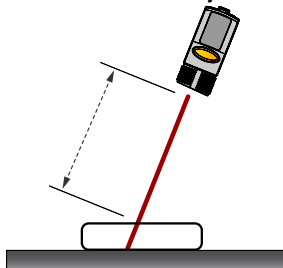

SOLUTION:
Move the sensor closer to the target

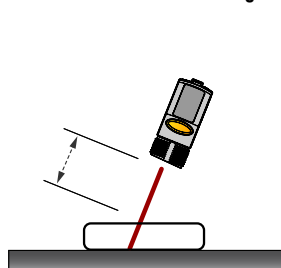

Figure 26. Common problems and solutions for detecting clear objects

6.4 Abbreviations

The following table describes the abbreviations used on the sensor display and in this manual.

Abbreviation	Description
----	No valid signal in range
9999	The sensor has not been taught
1Shot	One-shot
1st	First
2-Lr	Multiple light reflections
2nd	Second
2-Plt	Two-point TEACH (static background suppression)
Auto	Automatic
bOS	One-point background suppression
btn	Button
CanCL	Cancel
Comp	Complementary output
d.SP	Display read
dlAY	Delay
dlY1, dlY2	Output timing delay (Channel 1, Channel 2)
do	Dark operate
dt1, dt2	Delay timer (Channel 1, Channel 2)
duAL	Dual mode
dyn	Dynamic background suppression
End	End—exit the sensor menu
FAr	Far zero reference location—the maximum range is 0 and the measurement increase as the target moves closer to the sensor
FOs	One-point window (foreground suppression)
FULL	Full range
GA in	Excess gain
HIGH	High excess gain mode
HS	High speed tracking
Lo	Light operate
L on	Laser on

Abbreviation	Description
Loc	Lock/locked
LoFF	Laser off
MASt	Master
nEAR	Near zero reference location—the front of the sensor is 0 and the measurement increase as the target moves further away from the sensor
objct	Object
oFd1, oFd2	Off delay timer (Channel 1, Channel 2)
oFF	Off
oFS1, oFS2	Offset (Channel 1, Channel 2)
oFSt	An applied offset resulted in an invalid switch point
on	On
ond1, ond2	On delay timer (Channel 1, Channel 2)
out1, out2	Output (Channel 1, Channel 2)
PULS	Pulse frequency modulation
rSEt	Reset to factory defaults
SAVE	Save
SEt	Set or Input wire = remote teach function
SHFt	Shift the Zero Reference Location after a TEACH
SLVE	Slave
SPd	Response speed
Std	Standard excess gain mode
Strt	Start
StoP	Stop
tch1, tch2	TEACH process selection (Channel 1, Channel 2)
totL	Totalizer
tot1, tot2	Total counts
uLoc	Unlock/unlocked
uuu	Saturated signal (too much light)
Wnd1, Wnd2	Window size (Channel 1, Channel 2)
YES	Yes
ZEro	Zero—select the zero reference location

7 Troubleshooting

Table 15: Error Codes

Error Code	Description	Resolution
----	No valid signal in range	Reposition the sensor or the target
UUUU	The signal is saturated (too much light)	Reposition the sensor or the target to increase the detection distance, or increase the angle of incidence between the sensor and the target
ErrE	EEPROM fault	Contact Banner Engineering to resolve
ErrL	Laser fault	Contact Banner Engineering to resolve
ErrC	Output short-circuited	Check the wiring for an electrical short circuit and to ensure that the wiring is correct
ErrS	System fault	Contact Banner Engineering to resolve

8 Accessories

8.1 Cordsets

4-Pin Threaded M12/Euro-Style Cordsets				
Model	Length	Style	Dimensions	Pinout (Female)
MQDC-406	1.83 m (6 ft)	Straight		<p>1 = Brown 2 = White 3 = Blue 4 = Black</p>
MQDC-415	4.57 m (15 ft)			
MQDC-430	9.14 m (30 ft)			
MQDC-450	15.2 m (50 ft)			
MQDC-406RA	1.83 m (6 ft)	Right-Angle		
MQDC-415RA	4.57 m (15 ft)			
MQDC-430RA	9.14 m (30 ft)			
MQDC-450RA	15.2 m (50 ft)			

4-Pin Threaded M12/Euro-Style Cordsets—Washdown, Stainless Steel				
Model	Length	Style	Dimensions	Pinout (Female)
MQDC-WDSS-0406	1.83 m (6 ft)	Straight		<p>1 = Brown 2 = White 3 = Blue 4 = Black</p>
MQDC-WDSS-0415	4.57 m (15 ft)			
MQDC-WDSS-0430	9.14 m (30 ft)			

4-Pin Threaded M12/Euro-Style Cordsets—Double Ended				
Model	Length	Style	Dimensions	Pinout
MQDEC-401SS	0.31 m (1 ft)	Male Straight/ Female Straight		Female
MQDEC-403SS	0.91 m (3 ft)			
MQDEC-406SS	1.83 m (6 ft)			Male
MQDEC-412SS	3.66 m (12 ft)			
MQDEC-420SS	6.10 m (20 ft)			<p>1 = Brown 2 = White 3 = Blue 4 = Black</p>
MQDEC-430SS	9.14 m (30 ft)			
MQDEC-450SS	15.2 m (50 ft)			

4-Pin Threaded M12/Euro-Style Cordsets—Double Ended, Oil Resistant				
Model	Length	Style	Dimensions	Pinout
MQDEC-401SS-PUR	0.3 m (1 ft)	Male Straight/ Female Straight		Female
MQDEC-403SS-PUR	1 m (3.28 ft)			
MQDEC-406SS-PUR	2 m (6.56 ft)			Male
MQDEC-415SS-PUR	5 m (16.40 ft)			
MQDEC-430SS-PUR	10 m (32.81 ft)			<p>1 = Brown 2 = White 3 = Blue 4 = Black</p>

4-Pin Threaded M12/Euro-Style Cordsets—Double Ended, Washdown, Stainless Steel				
Model	Length	Style	Dimensions	Pinout
MQDEC-WDSS-401SS	0.3 m (1 ft)	Male Straight/ Female Straight		Female
MQDEC-WDSS-403SS	0.91 m (3 ft)			
MQDEC-WDSS-406SS	1.83 m (6 ft)			Male
MQDEC-WDSS-412SS	3.66 m (12 ft)			
				<p>1 = Brown 2 = White 3 = Blue 4 = Black</p>

8.2 Brackets

All measurements are listed in millimeters, unless noted otherwise.

SMBQ4X..

- Swivel bracket with tilt and pan movement for precision adjustment
- Easy sensor mounting to extruded rail T-slots
- Metric and inch size bolts available
- Side mounting of some sensors with the 3 mm screws included with the sensor

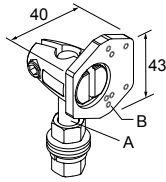

B = 7 × M3 × 0.5

Model	Bolt Thread (A)
SMBQ4XFAM10	M10 - 1.5 × 50
SMBQ4XFAM12	n/a; no bolt included. Mounts directly to 12 mm (½ in) rods

SMB18FA..

- Swivel bracket with tilt and pan movement for precision adjustment
- Easy sensor mounting to extruded rail T-slots
- Metric and inch size bolts available
- 18 mm sensor mounting hole

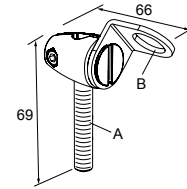

Hole size: B=ø 18.1

Model	Bolt Thread (A)
SMB18FA	3/8 - 16 × 2 in
SMB18FAM10	M10 - 1.5 × 50
SMB18FAM12	n/a; no bolt included. Mounts directly to 12 mm (½ in) rods

SMB18A

- Right-angle mounting bracket with a curved slot for versatile orientation
- 12-ga. stainless steel
- 18 mm sensor mounting hole
- Clearance for M4 (#8) hardware

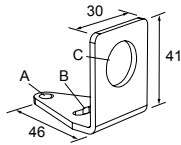

Hole center spacing: A to B = 24.2
Hole size: A = ø 4.6, B = 17.0 × 4.6, C = ø 18.5

SMBAMS18P

- Flat SMBAMS series bracket with 18 mm hole
- Articulation slots for 90+° rotation
- 12-ga. (2.6 mm) cold-rolled steel

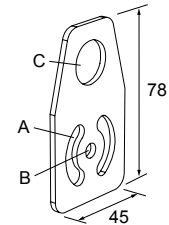

Hole center spacing: A = 26.0, A to B = 13.0
Hole size: A = 26.8 × 7.0, B = ø 6.5, C = ø 19.0

SMBAMS18RA

- Right-angle SMBAMS series bracket with 18 mm hole
- Articulation slots for 90+° rotation
- 12-ga. (2.6 mm) cold-rolled steel

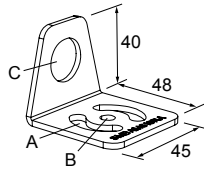

Hole center spacing: A = 26.0, A to B = 13.0
Hole size: A = 26.8 × 7.0, B = ø 6.5, C = ø 19.0

8.3 Aperture Kits—Threaded Barrel Models

APG18S

Kit with glass lens to protect plastic sensor lens from chemical environments and weld splatter damage.

Used with S18, M18, T18, TM18, and Q4X

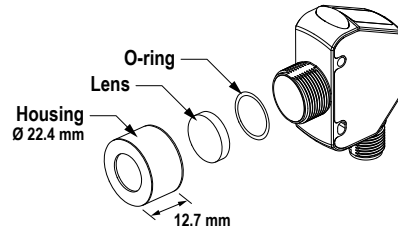

Additional Information

- Borosilicate glass window protects the PMMA window from weld splatter and chemicals
- Adds 4.8 mm to the length of the threaded barrel
- Reduces excess gain by 30%; increase the response time to restore excess gain

8.4 Reference Targets

All measurements are listed in millimeters, unless noted otherwise.

BRT-Q4X-60X18

- Reference target for clear object detection or dual mode applications
- FDA grade acetal material

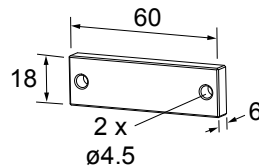

BRT-Q4X-60X50

- Reference target for clear object detection or dual mode applications
- FDA grade acetal material

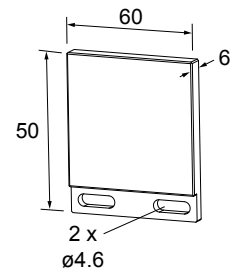

9 Contact Us

Corporate Headquarters

Address:
Banner Engineering Corporate
9714 Tenth Avenue North
Minneapolis, Minnesota 55441, USA

Phone: +1 763 544 3164
Website: www.bannerengineering.com

Europe

Address:
Banner Engineering EMEA
Park Lane Culliganlaan 2F
Diegem B-1831, Belgium

Phone: +32 (0)2 456 0780
Website: www.bannerengineering.com/eu
Email: mail@bannerengineering.com

Turkey

Address:
Banner Engineering Turkey
Barbaros Mah. Uphill Court Towers A Blok D:49
34746 Batı Ataşehir İstanbul Türkiye

Phone: +90 216 688 8282
Website: www.bannerengineering.com.tr
Email: turkey@bannerengineering.com.tr

India

Address:
Banner Engineering India Pune Head Quarters
Office No. 1001, 10th Floor Sai Capital, Opp. ICC Senapati Bapat Road
Pune 411016, India

Phone: +91 (0) 206 640 5624
Website: www.bannerengineering.co.in
Email: salesindia@bannerengineering.com

Mexico

Address:
Banner Engineering de Mexico Monterrey Head Office
Edificio VAO Av. David Alfaro Siqueiros No.103 Col. Valle Oriente C.P.66269
San Pedro Garza Garcia, Nuevo Leon, Mexico

Phone: +52 81 8363 2714 or 01 800 BANNERE (toll free)
Website: www.bannerengineering.com.mx
Email: mexico@bannerengineering.com

Brazil

Address:
Banner do Brasil
Rua Barão de Teffé nº 1000, sala 54
Campos Elíseos, Jundiaí - SP, CEP.: 13208-761, Brasil

Phone: +1 763 544 3164
Website: www.bannerengineering.com.br
Email: brasil@bannerengineering.com

China

Address:
Banner Engineering Shanghai Rep Office
Xinlian Scientific Research Building Level 12, Building 2
1535 Hongmei Road, Shanghai 200233, China

Phone: +86 212 422 6888
Website: www.bannerengineering.com.cn
Email: sensors@bannerengineering.com.cn

Japan

Address:
Banner Engineering Japan
Cent-Urban Building 305 3-23-15 Nishi-Nakajima Yodogawa-Ku
Osaka 532-0011, Japan

Phone: +81 (0)6 6309 0411
Website: www.bannerengineering.co.jp
Email: mail@bannerengineering.co.jp

Taiwan

Address:
Banner Engineering Taiwan
8F-2, No. 308 Section 1, Neihu Road
Taipei 114, Taiwan

Phone: +886 (0)2 8751 9966
Website: www.bannerengineering.com.tw
Email: info@bannerengineering.com.tw

10 Banner Engineering Corp. Limited Warranty

Banner Engineering Corp. warrants its products to be free from defects in material and workmanship for one year following the date of shipment. Banner Engineering Corp. will repair or replace, free of charge, any product of its manufacture which, at the time it is returned to the factory, is found to have been defective during the warranty period. This warranty does not cover damage or liability for misuse, abuse, or the improper application or installation of the Banner product.

THIS LIMITED WARRANTY IS EXCLUSIVE AND IN LIEU OF ALL OTHER WARRANTIES WHETHER EXPRESS OR IMPLIED (INCLUDING, WITHOUT LIMITATION, ANY WARRANTY OF MERCHANTABILITY OR FITNESS FOR A PARTICULAR PURPOSE), AND WHETHER ARISING UNDER COURSE OF PERFORMANCE, COURSE OF DEALING OR TRADE USAGE.

This Warranty is exclusive and limited to repair or, at the discretion of Banner Engineering Corp., replacement. IN NO EVENT SHALL BANNER ENGINEERING CORP. BE LIABLE TO BUYER OR ANY OTHER PERSON OR ENTITY FOR ANY EXTRA COSTS, EXPENSES, LOSSES, LOSS OF PROFITS, OR ANY INCIDENTAL, CONSEQUENTIAL OR SPECIAL DAMAGES RESULTING FROM ANY PRODUCT DEFECT OR FROM THE USE OR INABILITY TO USE THE PRODUCT, WHETHER ARISING IN CONTRACT OR WARRANTY, STATUTE, TORT, STRICT LIABILITY, NEGLIGENCE, OR OTHERWISE.

Banner Engineering Corp. reserves the right to change, modify or improve the design of the product without assuming any obligations or liabilities relating to any product previously manufactured by Banner Engineering Corp. Any misuse, abuse, or improper application or installation of this product or use of the product for personal protection applications when the product is identified as not intended for such purposes will void the product warranty. Any modifications to this product without prior express approval by Banner Engineering Corp will void the product warranties. All specifications published in this document are subject to change; Banner reserves the right to modify product specifications or update documentation at any time. Specifications and product information in English supersede that which is provided in any other language. For the most recent version of any documentation, refer to: www.bannerengineering.com.