

Ultrasonic Sensor

Level Control

LUS211-130-51-LI2UPN8-H1141

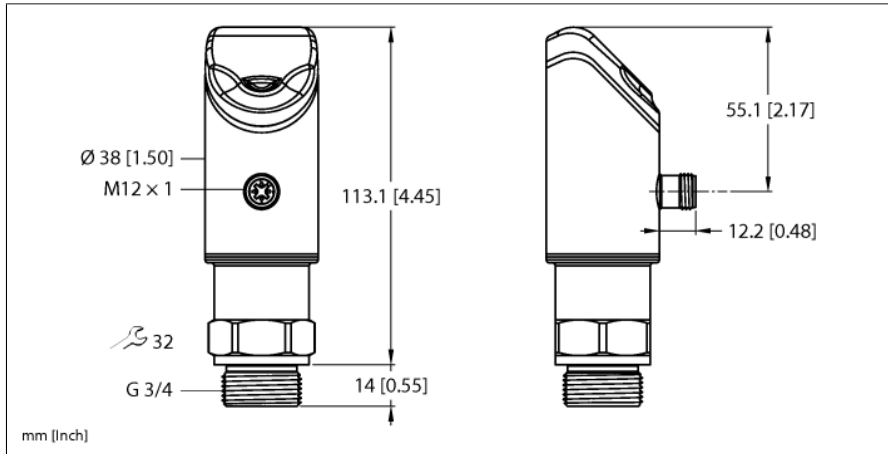

Type	LUS211-130-51-LI2UPN8-H1141
ID	100003169
Ultrasonic data	
Function	Proximity switch
Range	130...1300 mm
Resolution	1 mm
Minimum measuring range	100 mm
Minimum switching range	10 mm
Ultrasound frequency	200 kHz
Temperature drift	± 1.5% of full scale%
Edge lengths of the nominal actuator	100 mm
Approach speed	≤ 10 m/s
Pass speed	≤ 2 m/s
Electrical data	
Operating voltage	18...33 VDC
No-load current I ₀	≤ 150 mA
Load resistance	≤ 1000 Ω
Residual current	≤ 0.1 mA
Response time typical	< 90 ms
Readiness delay	≤ 300 ms
Communication protocol	IO-Link
Output function	NO/NC, PNP/NPN, analog output
Output 1	Switching output or IO-Link mode
Output 2	Analog output
Current output	4...20 mA
Load resistance current output	≤ 0.5 kΩ
Voltage output	0...10 V
Load resistance voltage output	≥ 8 kΩ
Switching frequency	≤ 6.5 Hz
Hysteresis	≤ 100 mm
Voltage drop at I _L	≤ 2.5 V
Short-circuit protection	yes
Reverse polarity protection	yes
Setting option	Capacitive Sensor IO-Link



- 4-digit, 2-colored, 12-segment display, rotatable by 180°
- Housing is rotatable after mounting the process connection
- G3/4" process connection
- Sealing ring included in delivery (stainless steel ring with NBR seal)
- Blind zone: 13 cm
- Range: 130 cm
- Resolution: 1 mm
- Aperture angle of sonic cone: ±16°
- 1 × switching output, PNP/NPN
- 1 × analog output, 4...20 mA / 0...10 V / additional switching output, PNP/NPN
- NO/NC programmable
- Transmission of process value and parametrization via IO-link

Wiring Diagram

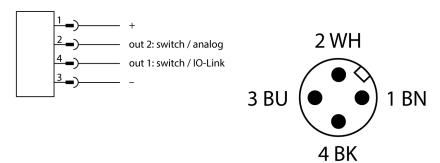

Functional principle

Ultrasonic sensors capture a multitude of objects contactlessly and wear-free with ultrasonic waves. It does not matter whether the object is transparent or opaque, metallic or non-metallic, firm, liquid or powdery. Even environmental conditions such as spray, dust or rain hardly affect their function.

The sonic cone diagram indicates the detection range of the sensor. In accordance with standard EN 60947-5-7, quadratic targets in

IO-Link	
IO-Link specification	V 1.1
IO-Link port type	Class A
Communication mode	COM 2 (38.4 kBaud)
Process data width	32 bit
Measured value information	15 bit
Switchpoint information	4 bit
Frame type	2.2
Minimum cycle time	5 ms
Function pin 4	IO-Link
Function Pin 2	DI
Maximum cable length	20 m
Profile support	Smart Sensor Profile
Included in the SIDI GSDML	Yes

Mechanical data	
Design	Smooth barrel, LUS
Radiation direction	straight
Dimensions	Ø 38 x 127.1 mm
Housing material	Stainless-steel/Plastic, 1.4404 (AISI 316L)/Grilamid TR90 UV
Transducer material	Plastic, Epoxyd resin and PU foam
Electrical connection	Connector, M12 × 1, 4-wire
Process connection	G 3/4"
Ambient temperature	-25...+70 °C
Pressure resistance	0.5...5 bar
Protection class	IP67 IP69K
	Not assessed by UL

Tests/approvals	
Declaration of conformity EN ISO/IEC	EN 60947-5-7
Approvals	CE cULus

a range of sizes (20 × 20 mm, 100 × 100 mm) and a round rod with a diameter of 27 mm are used.

Important: The detection ranges for other targets may differ from those for standard targets due to the different reflection properties and geometries.

Sonic Cone

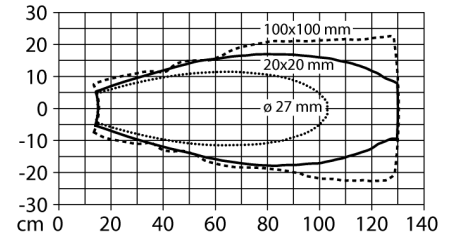

Function accessories

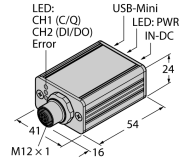
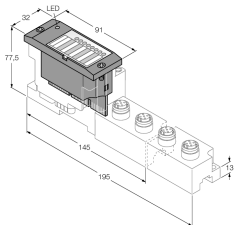
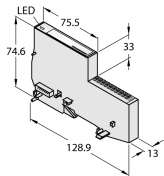
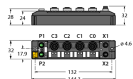
Type code	Ident no.		Dimension drawing
USB-2-IOL-0002	6825482	IO-Link Master with integrated USB port	 <p>LED-CH1 (C/Q) LED-CH2 (DI/DO) Error USB-Mini LED-PWR IN-DC</p> <p>24 54 41 16 M12 x 1</p>
BL67-4IOL	6827386	4-channel IO-Link Master module for the modular BL67 I/O-system	 <p>LED</p> <p>91 77.5 145 105</p>
BL20-E-4IOL	6827385	IO-Link master module for the modular BL20 I/O system, 4-channel	 <p>LED</p> <p>75.5 74.6 33 128.9 13</p>
TBEN-S2-4IOL	6814024	Compact multiprotocol I/O module, 4 IO-Link Master 1.1 Class A, 4 universal PNP digital channels 0.5 A	 <p>24 18 17 11 12 13 14 15 16 17 18 19 20 21 22 23 24</p> <p>128 144</p>