

# DX80DR2M-H6

## Radio Transmission System – Tree Topology

### Teilnehmer mit RS485-Schnittstelle

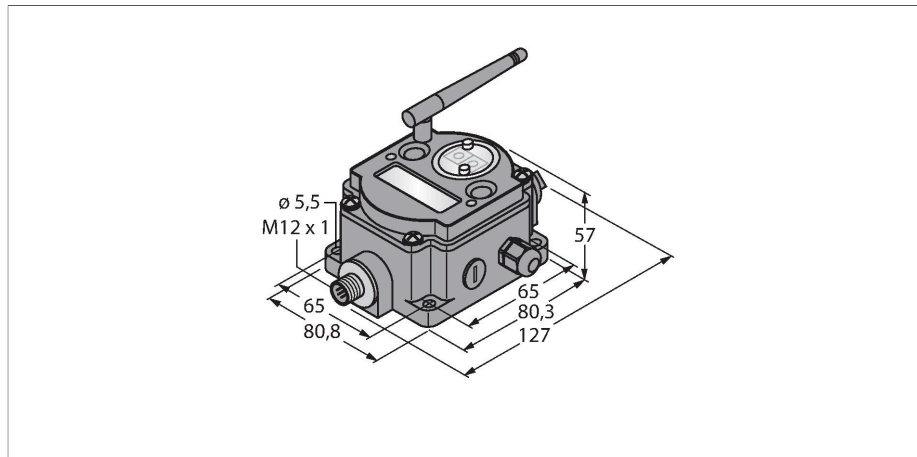

## Features

- External antenna (RG58 RP-SMA connection)
- Integrated signal strength indicator
- Configuration via DIP switch
- Modbus RTU (RS485)
- Self-organizing tree structure
- Repeater for extension of network
- Deterministic data transfer
- Frequency hopping FHSS
- Time Division Multiplex Access TDMA
- Transmission power: 63 mW, 18 dBm conducted,  $\leq 20$  dBm EIRP
- Inputs: Serial interface to connect a sensor
- Internal battery

## Technical data

Type	DX80DR2M-H6
ID	3014392
<b>Wireless data</b>	
Type of radio	short-range
Installation	stationary
Topology	Star topology
Function	Tree topology
Device type	Node
Frequency band	2.4-GHz ISM band
Frequency range	2.402 - 2.483 GHz
Number of radio channels	50
Channel width	1 MHz
Spread spectrum technology	FHSS (Frequency Hopping Spread Spectrum)
Single-Carrier Residence Time	7.8 ms
Response time typical	< 62.5 ms
Output power ERP	18 dB/65 mW
Output power EIRP	20 dB/100 mW
Range	3200000 mm
<b>I/O data</b>	
Number of channels	1
Input type	Serial interface
Communication protocol	1-wire-serial
<b>Electrical data</b>	
runs with battery	nein
Operating voltage	10...30 VDC

## Wiring diagram

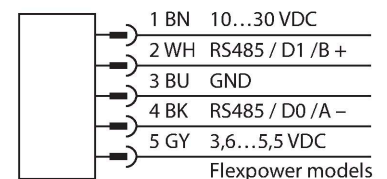

## Functional principle

The DX80 Data Radios are self-organizing. They create a network in tree topology. They transfer Modbus RTU telegrams or other data from other bus systems. The telegrams are routed through the network and lost radio communication is compensated via alternative routes. Further sensors can be added to the network and their data is accessible via internal registers. Each network consists of a master and an unlimited number of repeaters or slaves. The device type is adjusted via DIP switch. This system can be combined with several DX80 networks to transfer data from the DX80 gateway via Modbus RTU to the control system.

### Directives:

FCC-ID UE300DX80-2400. This device complies with FCC para. 15, subpara. C, 15.247

ETSI/EN: In compliance with EN 300 328: V1.8.1 (2014-04)

IC: 7044A-DX8024

Radiation protection 10 V/m for 80-2700 MHz acc. to EN 61000-6-2

Shock and vibration resistant: IEC 68-2-6 and IEC 68-2-7

## Technical data





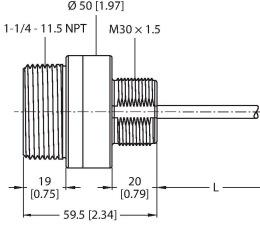
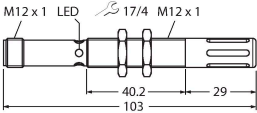
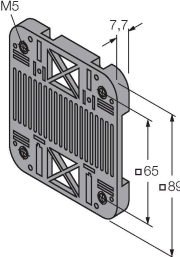





DC rated operational current	≤ 60 mA
Power-on indication	LED, Green
<b>Mechanical data</b>	
Design	Rectangular, DX80DR
Dimensions	127 x 80.8 x 57 mm
Housing material	Plastic, PC
Antenna connection	RP-SMA female connector
Ambient temperature	-20...+80 °C
Relative humidity	0...95 %
Protection class	IP67
<b>Tests/approvals</b>	
Approvals	ATEX II 3 G

## Accessories

<p><b>BWA-BATT-001</b></p> <p>3078261</p> <p>Lithium-ion battery, D cell, 3.6 VDC, 19,000 mAh, American supplier, GGV UN3090/CL9</p> <p>Keine Maßzeichnung vorhanden! No drawing available!</p>		<p><b>K50UX1CRA</b></p> <p>3094613</p> <p>Ultrasonic sensor, diffuse-mode sensor, 3 m range, serial interface for connection to DX80 nodes</p> 	
<p><b>M12FTH4Q</b></p> <p>3025895</p> <p>Temperature and humidity sensor, metal housing, protection class IP67, serial interface for connection to DX80 nodes</p> 		<p><b>SMBDX80DIN</b></p> <p>3077161</p> <p>Mounting panel for DIN rail, suited for CP80, DX80, K80, Q80, operating temperature: -20...90 °C</p> 	

## Accessories

Dimension drawing	Type	ID	
<p>Keine Maßzeichnung vorhanden! No drawing available!</p>	<p>BWC-LMRSFRPB</p>	<p>3079296</p>	<p>Surge protection, bulkhead fitting, RP-SMA type</p>
	<p>BWC-1MRSFRSB0.2</p>	<p>3078544</p>	<p>Antenna extension, RP-SMA on RP-SMAF bulkhead fitting, 0.2m, RG58, loss 1.05 dB/m</p>

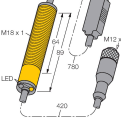
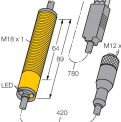
Dimension drawing	Type	ID	
	BWC-1MRSFRSB1	3078337	Antenna extension, RP-SMA on RP-SMAF bulkhead fitting, 1 m, RG58, loss 1.05 dB/m
	BWC-1MRSFRSB2	3078338	Antenna extension, RP-SMA on RP-SMAF bulkhead fitting, 2m, RG58, loss 1.05 dB/m
	BWC-1MRSFRSB4	3077488	Antenna extension, RP-SMA on RP-SMAF bulkhead fitting, 4m, RG58, loss 1.05 dB/m
	BWC-1MRSMN05	3077486	Antenna extension, RP-SMA on N-male, 0.5 m, RG58, loss 0.56 dB/m
	BWC-1MRSMN2	3077820	Antenna extension, RP-SMA on N-male, 2m, RG58, loss 0.56 dB/m
	BWC-4MNFN3	3077489	Antenna extension, N male connector to N female connector, cable length: 3 m, LMR400, coaxial, loss: 0.22 dB/m
	BWC-4MNFN6	3077490	Antenna extension, N-male on N-female, 6m, LMR400, coaxial, loss 0.22 dB/m
	BWC-4MNFN15	3077821	Antenna extension, N-male on N-female, 15 m, LMR400, coaxial, loss 0.22 dB/m
	BWC-4MNFN30	3077822	Antenna extension, N-male on N-female, 30m, LMR400, coaxial, loss 0.22 dB/m
	VBRK4.5-2RSC4.874T-0.15/0.15/ TXL	6634679	Y-piece with cable, 1 × M12 × 1 female connector to 2 × M12 × 1 male connector; for separate supply of DX80 radio components when connected to the PC via USB adapter
	BWA-HW-006	3081325	Converter cable, RS485 to USB 2.0 converter, female connector, M12 × 1, 5-pin, male connector, USB type A, length 1 m; supplies the connected device with 10 V. An external power supply via a Y-splitter (6634679) is recommended for the connected device
	BWA-UCT-900	3019970	Converter cable with DC power supply for parameterizing DX80 networks via PC, RS485 to USB 2.0 converter, female connector, M12 × 1, 5-pin, male connector, USB type A, length 1 m; supplies the connected device with 10 V

Accessories

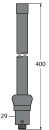
Dimension drawing	Type	ID	
	BWA-2O6-A	3081081	External antenna 6 dBi, N-female
	BWA-2O8-A	3081080	External antenna 8.5 dBi, N-female
	BWA-2O2-C	3077816	Internal antenna 2 dBi, RP-SMA male, standard
	BWA-2O5-C	3077817	Internal antenna 5 dBi, RP-SMA male
	BWA-2O7-C	3077818	Internal antenna 7 dBi, RP-SMA male