

TP-203A-CF-H1141-L100

Temperature Detection – Probe

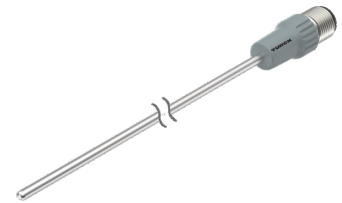
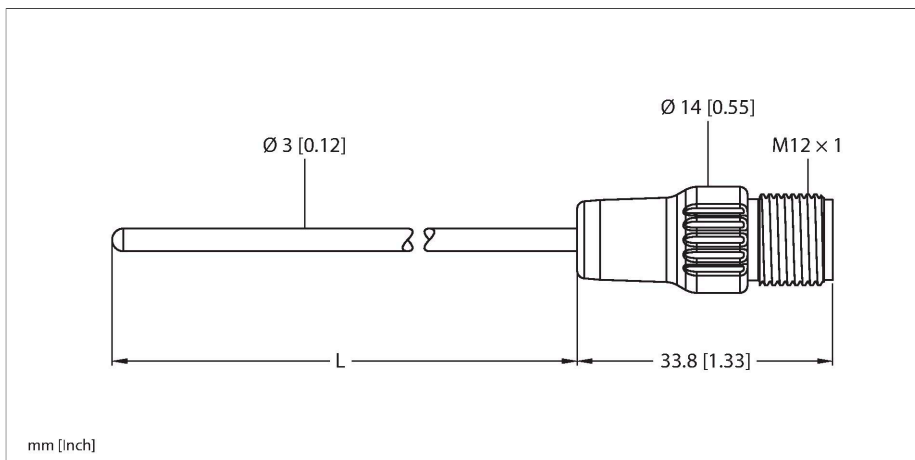

Technical data

Type	TP-203A-CF-H1141-L100
ID	9910402
Temperature range	
Measuring range	-50...500 °C -58...932 °F
Accuracy	$\pm 0.15 \text{ K} + 0.002 \cdot t $ (-30...300 °C)
Self-heating	0.4 K/mW at 0 °C
Measuring element	Pt100, DIN EN 60751, class A; connection mode: 4-wire connection
Response time	$t_{0.5} = 1.5 \text{ s} / t_{0.9} = 6.0 \text{ s}$ in water at 0.2 m/s
Immersion depth L	100 mm
Outer diameter	3 mm
Protection class	IP67
Environmental conditions	
Ambient temperature	-40...+120 °C
Storage temperature	-40...+85 °C
Mechanical data	
Housing material	Stainless steel, 1.4404 (AISI 316L)
Sensor material	Stainless steel, 1.4404 (AISI 316L)
Process connection	For compression fittings, thermowell or direct mounting
Pressure resistance	100 bar
Electrical connection	Connector, M12 × 1
Core cross-section	4 mm ²
Reference conditions acc. to IEC 61298-1	
Temperature	15...+25 °C

Features

- Max. temperature connector: 120°C
- Connection mode: 4-wire connection
- Process connection via compression fitting or thermowell
- Bendable probe (min. bending radius: 3x outer diameter; excluding 30-mm probe tip)

Wiring diagram

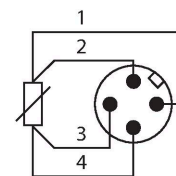



Functional principle

Resistance thermometers are used for the detection and monitoring of temperatures to optimize and control a process. Typical applications are in machine and plant construction as well as in the process industry. The core element of the temperature probe is a temperature-dependent resistor.



Technical data

Atmospheric pressure	860...1060 hPa abs.
Humidity	45...75 % rel.
Auxiliary power	24 VDC
Tests/approvals	
Approvals	cULus
UL registration number	E345414
MTTF	2283 years acc. to SN 29500 (Ed. 99) 20 °C

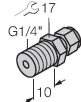
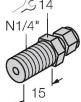
Accessories

CF-M-3-G1/8-A4	9910405	CF-M-3-N1/8-A4	9910406
	Compression fitting for direct mounting of temperature sensors; sensor diameter 3 mm; process connection G1/8" male thread		Compression fitting for direct mounting of temperature sensors; sensor diameter 6 mm; process connection 1/8" NPT male thread
CF-M-3-G1/4-A4	9910407	CF-M-3-N1/4-A4	9910408
	Compression fitting for direct mounting of temperature sensors; sensor diameter 3 mm; process connection G1/4" male thread		Compression fitting for direct mounting of temperature sensors; sensor diameter 3 mm; process connection 1/4" NPT male thread

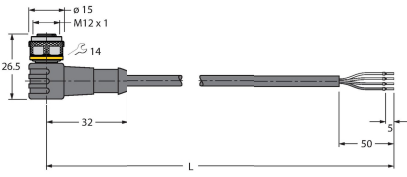
Accessories

Dimension drawing	Type	ID	
	WKC4.4T-2/TEL	6625025	Connection cable, M12 female connector, angled, 4-pin, cable length: 2 m, jacket material: PVC, black; cULus approval
	RKC4.4T-2/TEL	6625013	Connection cable, M12 female connector, straight, 4-pin, cable length: 2 m, jacket material: PVC, black; cULus approval

Dimension drawing	Type	ID	
	RKC4.4T-2/TXL	6625503	Connection cable, M12 female connector, straight, 4-pin, cable length: 2 m, jacket material: PUR, black; cULus approval
	WKC4.4T-2/TXL	6625515	Connection cable, M12 female connector, angled, 4-pin, cable length: 2 m, jacket material: PUR, black; cULus approval

Accessories

Dimension drawing	Type	ID	
	TTM-100-LIUPN-H1140	9910632	Miniature transmitter for external probes