

TP-306A-CF-H1141-L5000

Temperature detection Probe

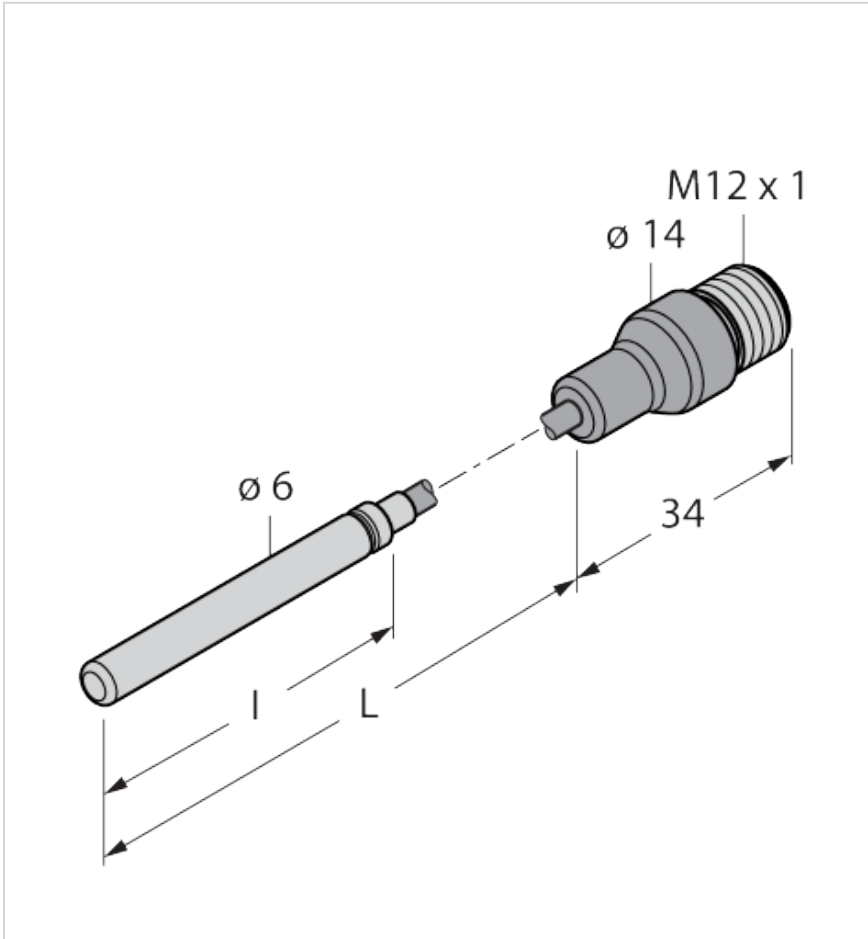

Typ	TP-306A-CF-H1141-L5000
Ident-No.	9910481

Technical data

General data	
Detection type	medium contact
Measuring principle	Media-contacting
Application area	
Immersion depth (L)	5000 mm
Measuring element	Pt100, DIN EN 60751, class A; connection mode: 4-wire connection
Detection area/measuring range	

Features

- Pt100 probe according to DIN EN 60751
- Resistant to vibrations and shocks
- Connectable to TS, TTM, IM34, BL20, BL67
- Max. temperature connector: 120 °C
- Connection mode: 4-wire connection

Wiring Diagram

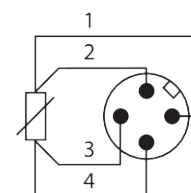

Technical data

Measuring range	-50...105 °C
Measuring range	-58...221 °F
Temperature	
Temperature measuring range	-50...105 °C
Self-heating	0.4 K/mW at 0 °C
Electrical data	
Response time	t 0.5 = 8 s / t 0.9 = 20 s in water at 0.2 m/s
Outputs	
Electrical output	Resistance
Accuracy/deviation	
Accuracy	±0.15 K + 0.002 · t (-30...300 °C)
Mechanical data	
Design	Temperature probe
Construction type designation	TP
Housing material	Stainless steel, 1.4404 (AISI 316L)
Electrical connection	Connector, M12 × 1
Outer diameter	6 mm
Process connection	For compression fittings, for direct mounting
Sensor material	Stainless steel, 1.4404 (AISI 316L)
Length sleeve (l)	50 mm
Cable	
Core cross-section	4
Environmental conditions	
Protection class	IP67
Tests/approvals	
UL registration number	E345414
Approvals	cULus
Approvals	cULus
MTTF	2283 Jahre acc. to SN 29500 (Ed. 99) 20 °C
Reference conditions	
Auxiliary power	24 VDC
Atmospheric pressure	860...1060 hPa abs.
Humidity	45...75 % rel.
Temperature	15...+25 °C

Functional principle

Resistance temperature detectors are used for the detection and monitoring of temperatures to optimize and control a process.

Typical applications are in machine and plant construction as well as in the process industry.

The core element of the temperature probe is a temperature-dependent resistor.

Connectivity accessories

WKC4.4T-2/TEL

6625025

Connection cable, M12 female connector, angled, 4-pin, cable length: 2 m, jacket material: PVC, black; cULus approval

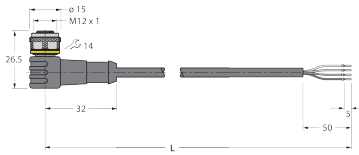

RKC4.4T-2/TEL

6625013

Connection cable, M12 female connector, straight, 4-pin, cable length: 2 m, jacket material: PVC, black; cULus approval

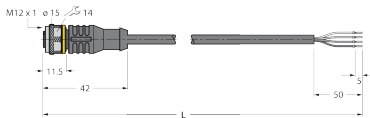

RKC4.4T-2/TXL

6625503

Connection cable, M12 female connector, straight, 4-pin, cable length: 2 m, jacket material: PUR, black; cULus approval



WKC4.4T-2/TXL

6625515

Connection cable, M12 female connector, angled, 4-pin, cable length: 2 m, jacket material: PUR, black; cULus approval

